

**140**  
1879 - 2019

*ENGINEERING*  
*YOUR SPRAY SOLUTION*

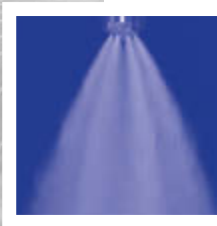

## Precision Spray Nozzles and Engineered Solutions for the Power Plant Industry

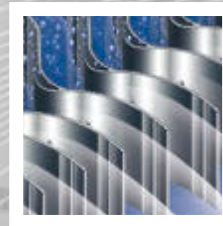
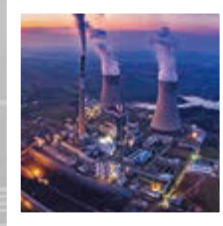
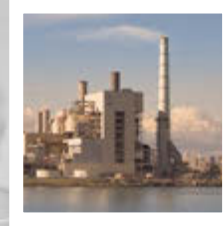
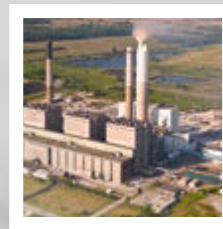

**Power Plant Industry**

# EFFICIENT COOLING AND CONDITIONING WITH LECHLER NOZZLE LANCES AND SYSTEMS

Lechler is Europe's No. 1 and is also one of the leading suppliers of nozzles and systems worldwide. For over 140 years, we have pioneered numerous groundbreaking developments in the field of nozzle technology. We combine comprehensive nozzle engineering expertise with a deep understanding of application-specific requirements to create products that offer outstanding performance and reliability.



## Innovative solutions for a trending market

Power plant operators are faced with many different challenges. On the one hand, they must guarantee a reliable and continuous supply of power. On the other hand, strict emission requirements are creating a constant pressure to invest and innovate. In addition, the development of renewable energy techno-

logies means that new competitors are arriving on the market to which it is also necessary to react.

Efficient gas conditioning offers a wide range of approaches to reducing costs and increasing efficiency. A prerequisite is that the respective processes are thoroughly understood and that the gas conditioning is adapted accordingly.

## The right solution for every requirement

With our wide range of nozzles, gas conditioning systems and droplet separators, we offer the perfect solution for every application. Every power plant naturally comes with its own set of challenges.

We rise to these challenges and work with you to develop the best solutions for your business. We support you with comprehensive consulting services ranging from process analysis to turnkey solutions.

1879

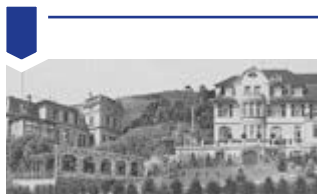

Company founded by Paul Lechler

1893



Patent for liquid atomization

1962



Sales offices set up in Germany

1978



Expansion to the USA and then to other countries

# COMPETENCE – THE ADVANTAGE OF MULTIPLE PERSPECTIVES

ENGINEERING  
YOUR SPRAY SOLUTION



## CUSTOMER ADVANTAGES

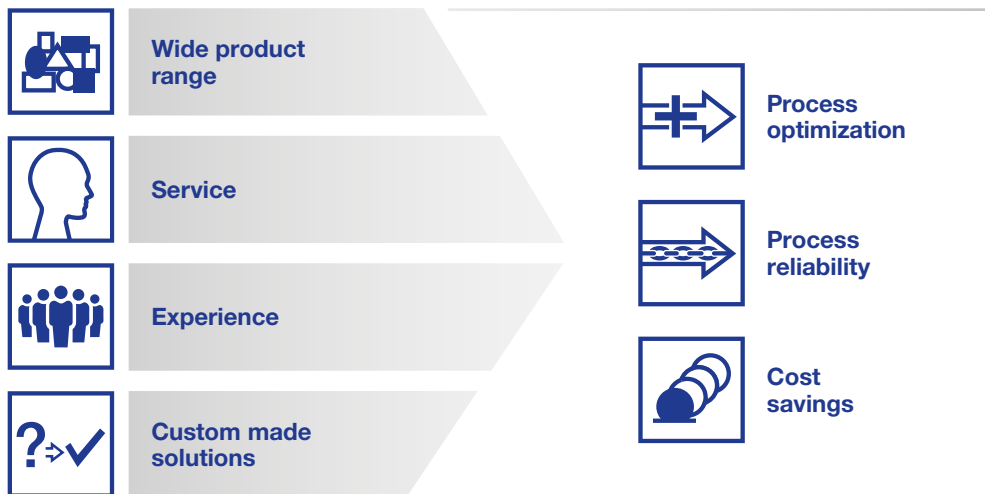

CONTENTS	Page
<b>Applications</b>	<b>4–9</b>
<b>Choosing the right nozzle</b>	<b>10</b>
Spillback nozzles	11
VarioJet® nozzles	12
Laval nozzles	13
Special twin-fluid nozzles for DeNOx applications	14–15
<b>Nozzle lances</b>	<b>16–17</b>
<b>VarioCool® gas cooling system</b>	<b>18–21</b>
<b>Lechler Online Cleaning (LOC®)</b>	<b>22–23</b>
<b>Engineering and service</b>	<b>24–25</b>
<b>CFD Analysis</b>	<b>26–27</b>
<b>Nozzles for flue-gas desulfurization</b>	<b>28–31</b>
<b>Droplet separator systems</b>	<b>32–35</b>
<b>Measuring technology</b>	<b>36–38</b>
<b>Quality with a system</b>	<b>38</b>

For many years now, nozzles, spray systems and droplet separators for industrial gas conditioning have been an integral part of our Environmental Technologies portfolio. An international team of outstanding engineers and process engineers continuously develop new solutions and adapt them to new challenges.

Through the use of global databases and close cooperation with external specialized institutes and renowned plant manufacturers, we have built up an interdisciplinary knowledge base – and with it optimal process integration.

Our constant exchange of experiences with power plant operators means we are always in tune with the latest developments and can react proactively to them.

To provide you with local support, we are represented all around the globe – with locations in the USA, Great Britain, India, China, ASEAN, France, Belgium, Italy, Finland, Hungary, Spain and Sweden, as well as sales partners in almost every country.

### Costs under control

In the flue-gas treatment installations of power plants extreme ambient conditions prevail. We manufacture our nozzles and droplet separators from highly resistant materials with minimal wear.

The long service life of our high-quality components for valve skid units and systems does not just reduce the pure costs of spare parts, but also decreases downtimes and maintenance costs. In addition, customer-specific systems lower the operating costs to a minimum.

Twin-fluid nozzles allow for an application-optimized fine droplet spectrum, whereas spillback systems do away with compressed air altogether to reduce the energy consumption.

**Our job is to identify the appropriate solution in each case and then adapt it perfectly to the on-site conditions.**

1988



Environmental Technologies division founded

1995



Production, sales and administration are concentrated in Metzingen

2010



Expansion of production with new 13,000 m<sup>2</sup> production hall

2016



Opening of the ultra-modern Development and Technology Center in Metzingen

# OVERVIEW OF LECHLER APPLICATIONS IN POWER PLANTS

## Flue-gas denitrification DeNO<sub>x</sub> SCR, high dust

Atomization of aqueous ammonia for catalytic reduction of nitrogen oxides.

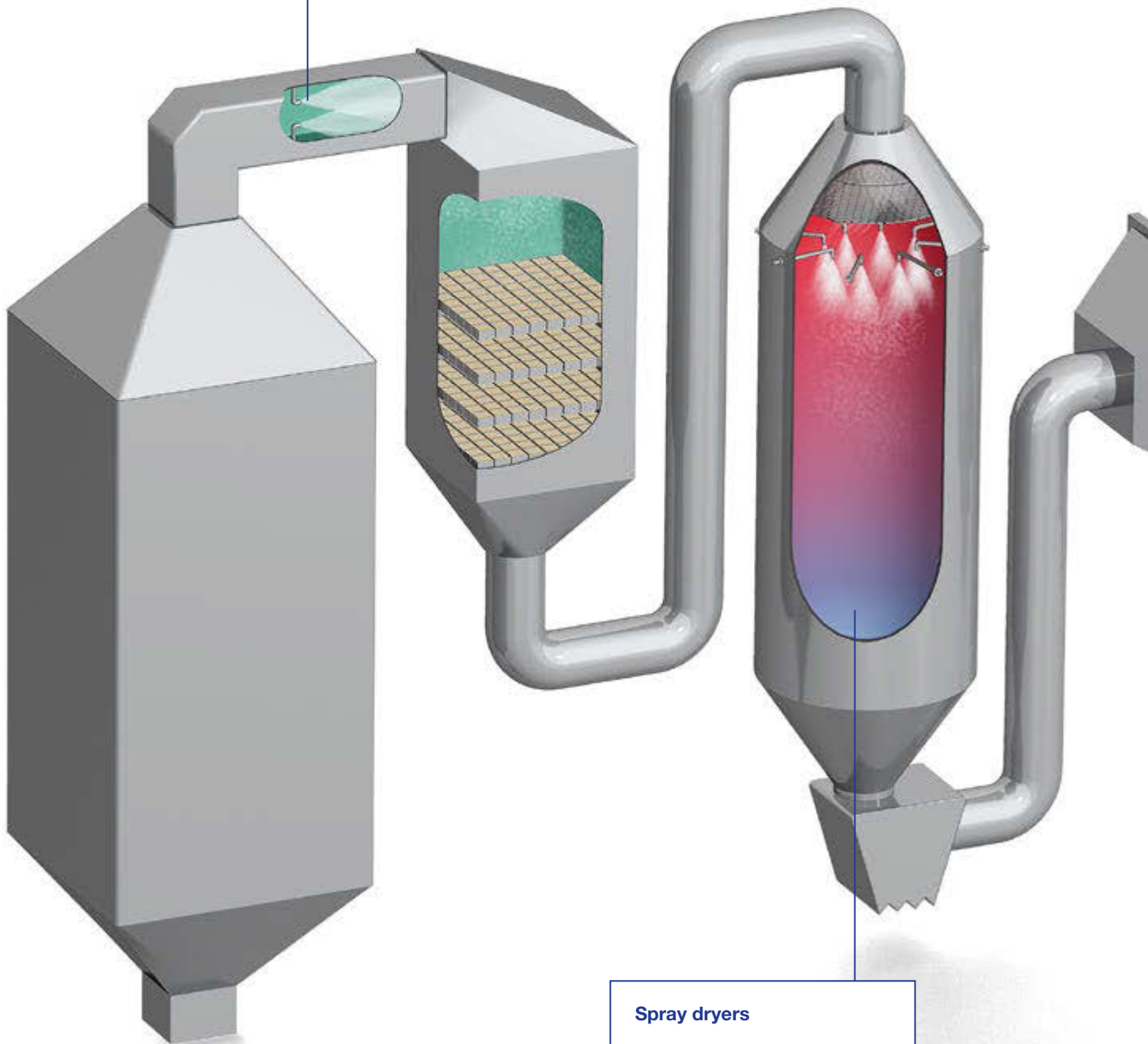

## Spray dryers

Atomization of liquids for waste water-free operation.

**Wet flue-gas desulfurization  
DeSO<sub>x</sub>**

Atomization of suspensions for  
separation of SO<sub>2</sub>.

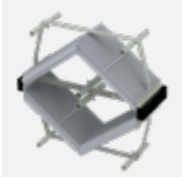

**Highly efficient  
droplet separator systems**

For wet flue gas  
desulfurization.



**Atomization of water  
for emergency cooling**

**Wall and floor rinsing with  
flat fan and tongue-type nozzles  
to remove deposits**

# OVERVIEW OF LECHLER APPLICATIONS IN POWER PLANTS

## Spray absorbers Semi-dry process for DeSO<sub>x</sub>

Atomization of lime slurry suspensions  
for binding SO<sub>2</sub>.

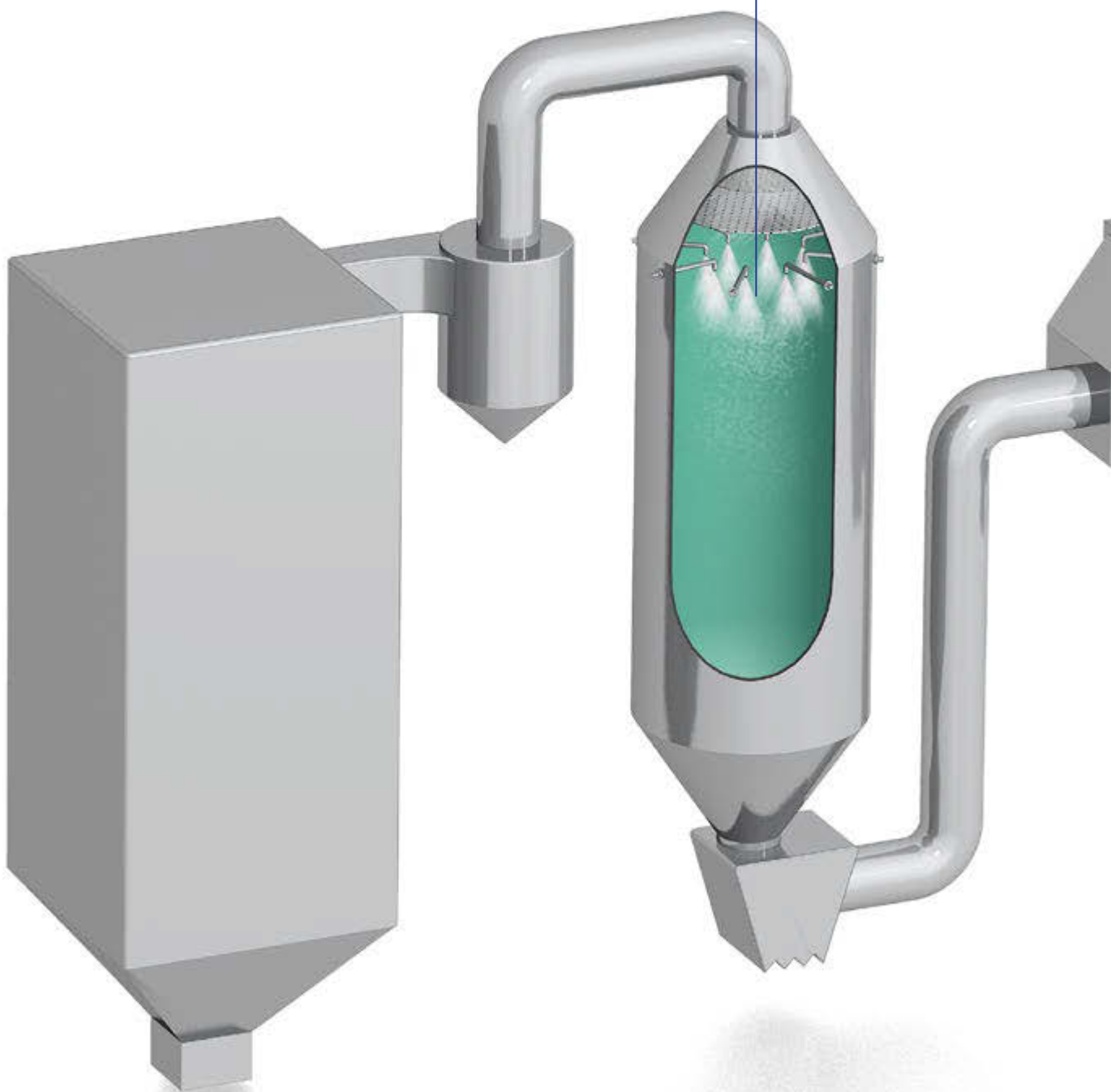

**Flue-gas denitrification  
DeNO<sub>x</sub> SCR, low dust/tail end**

Atomization of aqueous ammonia  
for catalytic reduction of NO<sub>x</sub>.

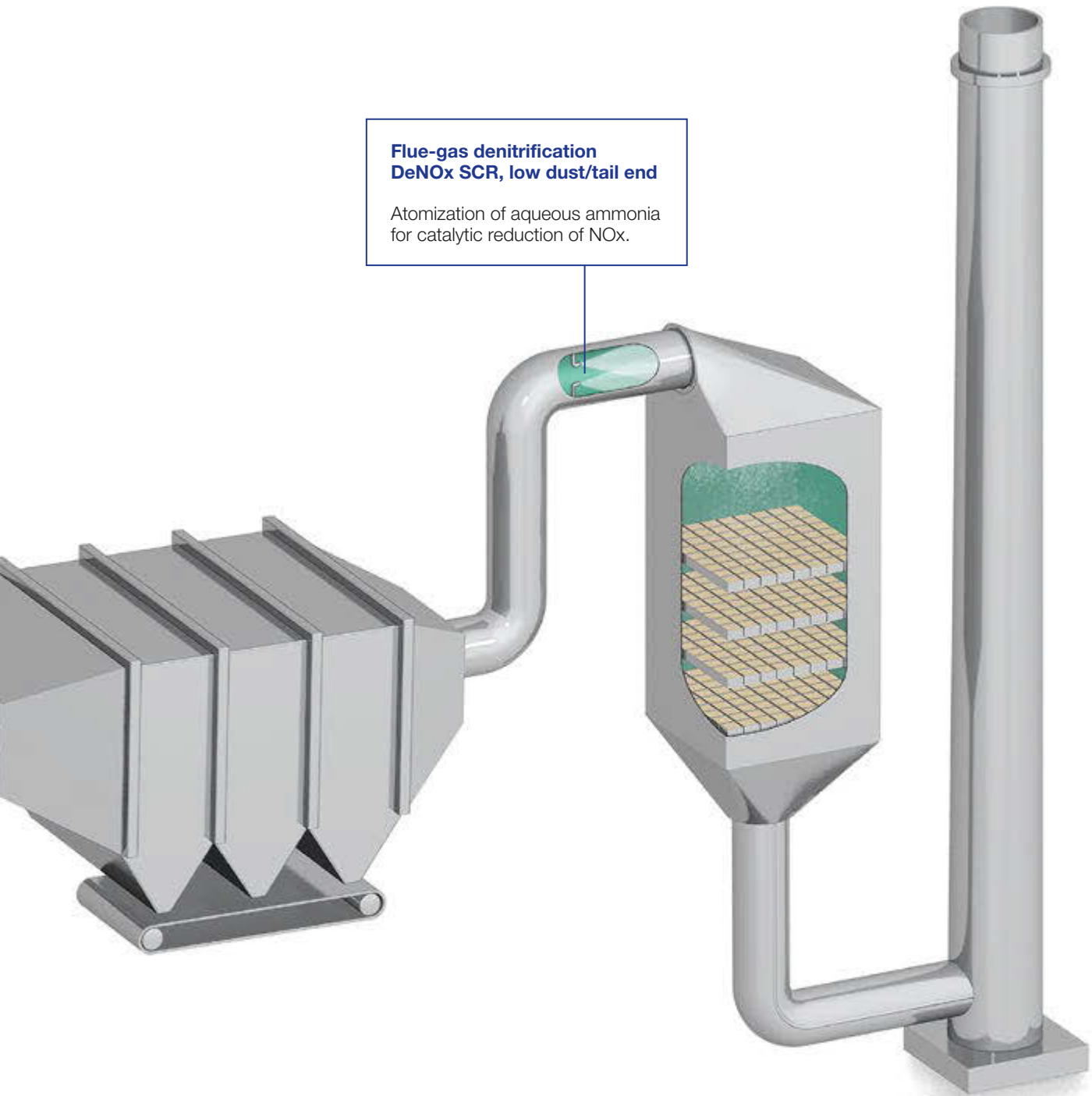

# OVERVIEW OF LECHLER APPLICATIONS IN POWER PLANTS

## CFB Dry process DeSO<sub>x</sub>

Injection into circulating fluidized bed for humidification and reaction acceleration.

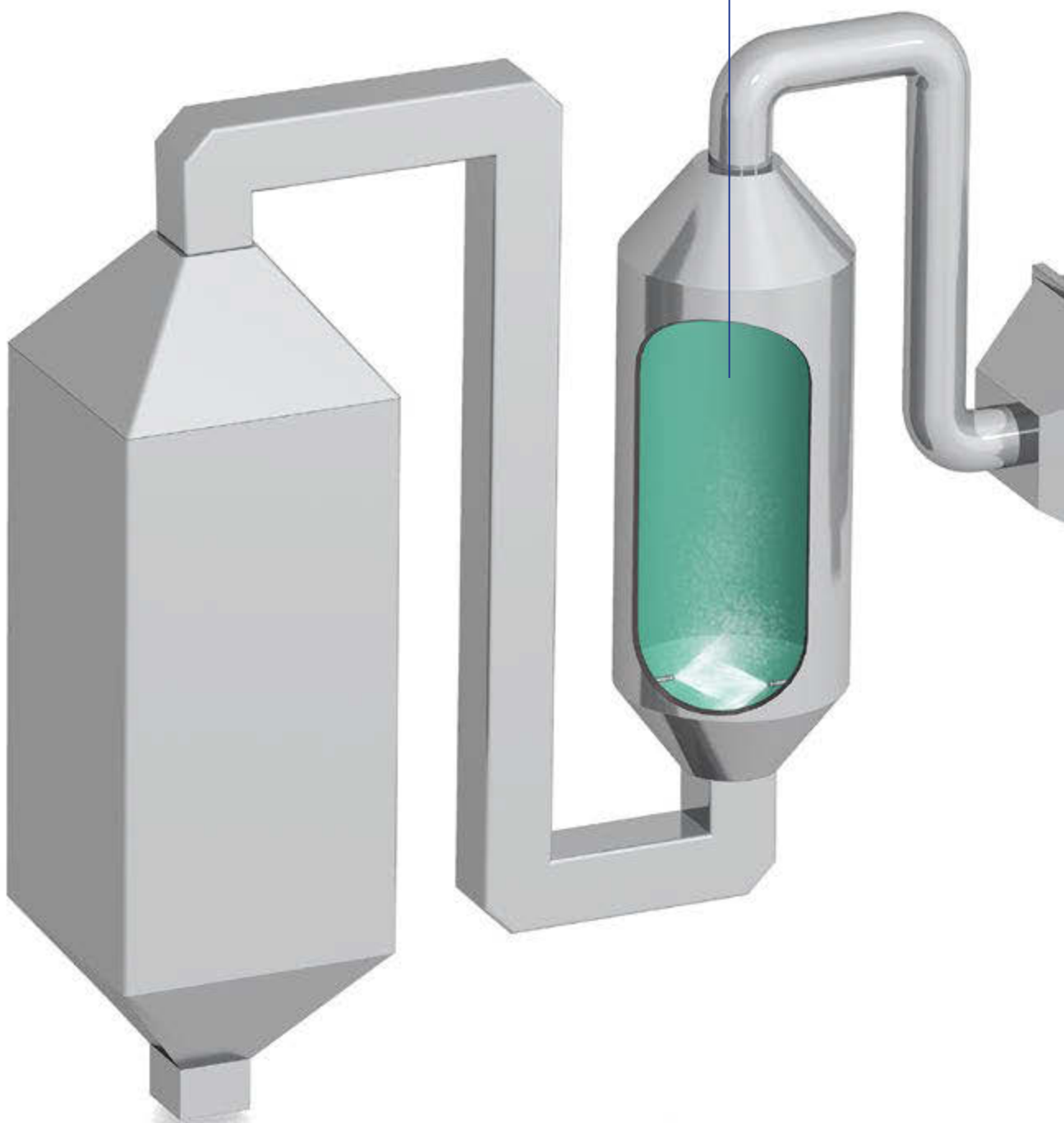



**Flue-gas denitrification  
DeNOx SCR, low dust/tail end**

Atomization of aqueous ammonia for  
catalytic reduction of nitrogen oxides.

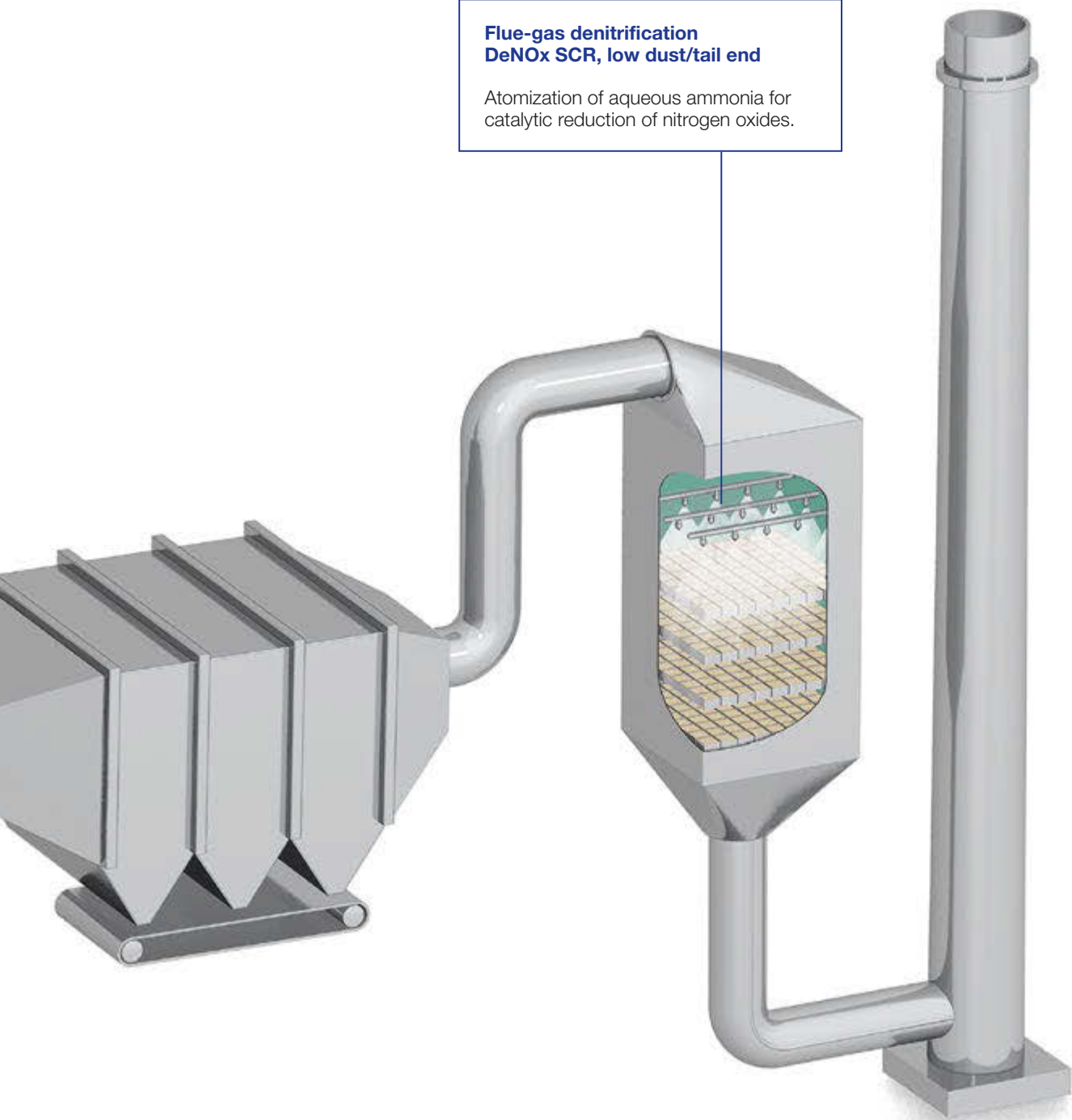

# CHOOSING THE RIGHT NOZZLE



Best results are achieved in gas cooling and conditioning processes only when detailed knowledge of process-specific requirements is available to assist in the choice of nozzles.

**We will provide you with comprehensive advice taking your system and the applications you require into account. Our portfolio includes nozzles made of different materials for a wide range of droplet sizes and spray angles. The combination of your specific process requirements and our decades of experience results in a tailor-made solution for your needs.**



# Spillback nozzles

## Atomization without compressed air



**Lechler spillback nozzles** atomize liquids as a fine hollow cone.

This special single-fluid nozzle works according to the pressure atomization principle. The water is sent to the nozzle with a relatively constant feed pressure, independent of the atomized flow rate.

The amount of liquid injected is adjusted via a control valve in the spillback line, whereby part of the flow is taken from the inlet flow rate and returned to the tank. The maximum atomized flow rate is achieved with the control valve closed.

Uniform and fine liquid atomization is achieved across the entire control range.

The atomized flow rate can be distributed over cluster heads with up to six small nozzles. This results in a total spray angle of approximately 120°. This wide distribution of liquid over the entire duct is advantageous for reducing the number of lances.

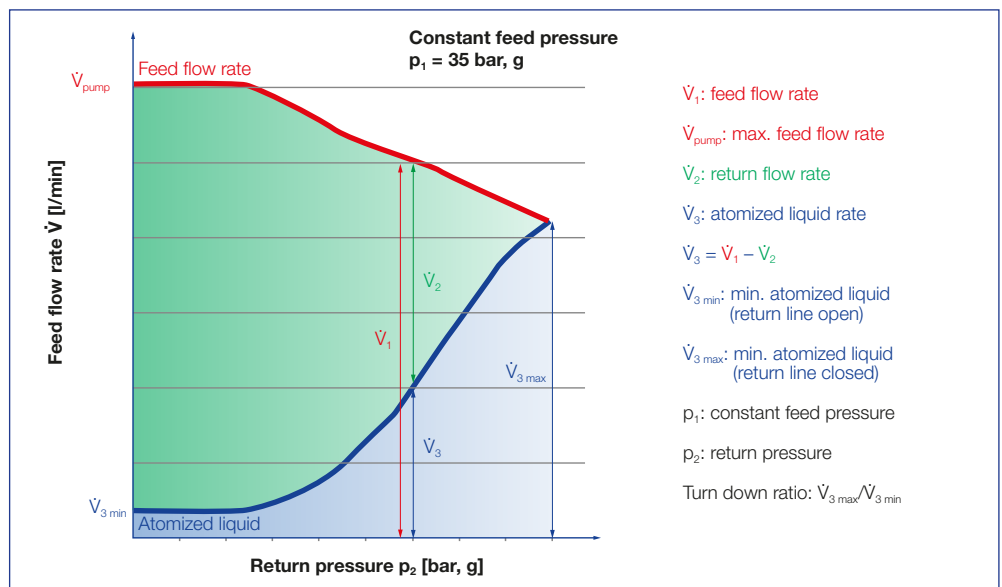
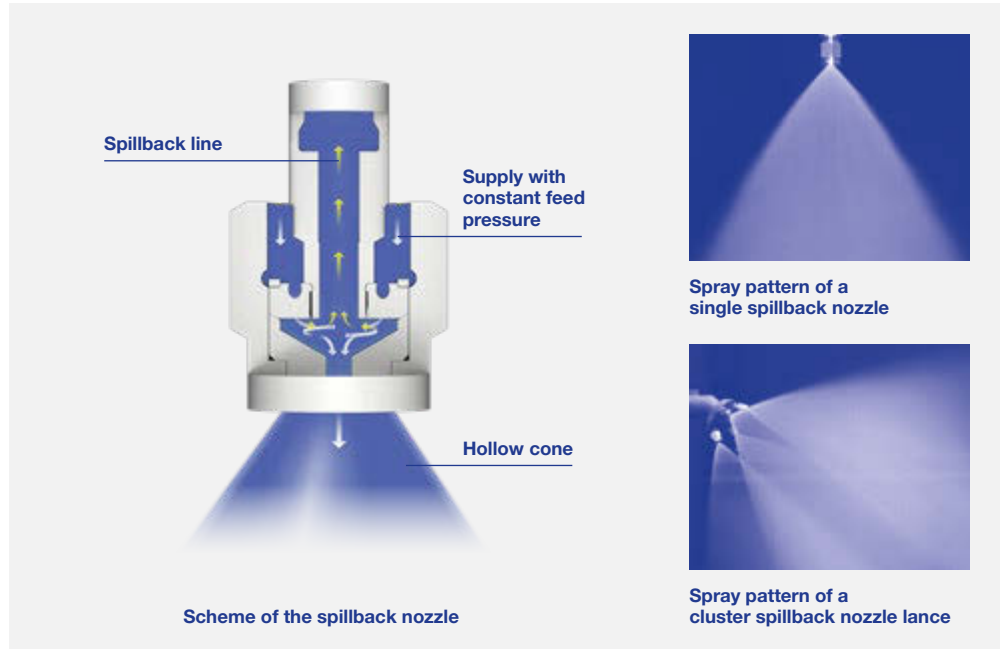

### Use:

- Gas cooling in medium-sized and large gas cooling towers

### Properties



**Spray angle of the individual nozzles**  
90° or 60°  
as hollow cone



**Low operating costs** as no atomizing air required



**Execution**  
as single or cluster nozzle lances possible



**High turn-down ratio**  
of up to 12:1



**Even and fine liquid atomization**  
over the entire control range



**Typical pressure range**  
of 35 bar, g in the supply line at the nozzle

# VarioJet® nozzles

Twin-fluid nozzles with low air consumption despite large outlet angle



**Lechler VarioJet® nozzles** atomize according to the principle of internal mixing. With this twin-fluid nozzle, the water is fed in axially via a bore hole.

After arriving at the cone tip, the liquid is split up into a thin liquid film. This thin liquid film is split into finest droplets by the atomizing air in the mixing chamber. The resulting two-phase mixture is then atomized a second time when exiting via several bore holes arranged in a circular fashion.

Thanks to the innovative design of the nozzle, a spray with a large outlet angle is achieved. This is characterized by an even liquid distribution as well as a fine droplet spectrum with a low specific air consumption.

The fineness of the droplet spectrum is decisively influenced by the air/liquid ratio and by the pressure level of the two flow rates. As a general rule: the higher the air/liquid ratio and the higher the pressure level of atomizing air and liquid is, the finer the droplet spectrum.

The large free cross-sections in the nozzle keep the risk of clogging and the maintenance effort to a minimum.

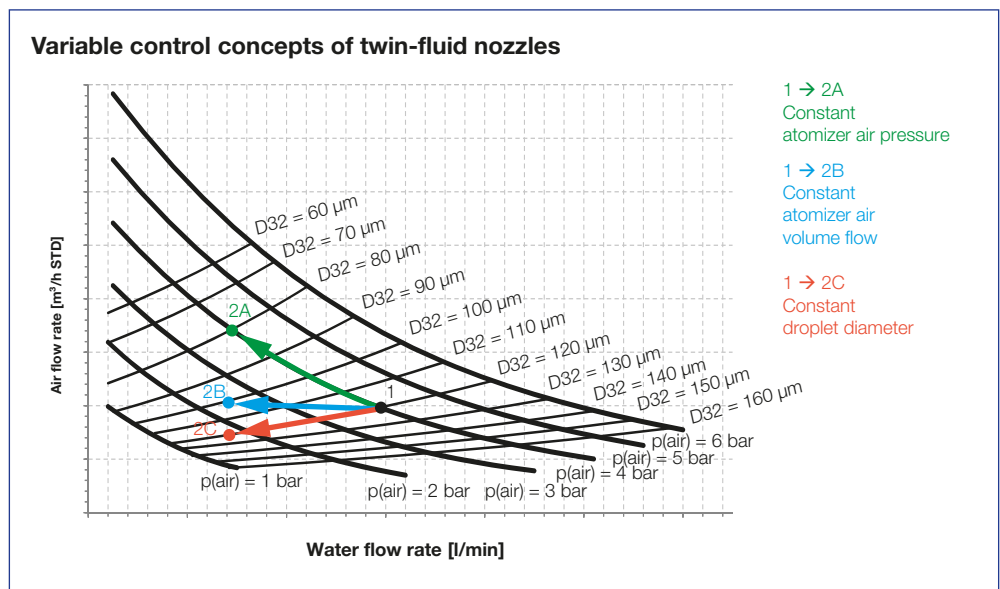
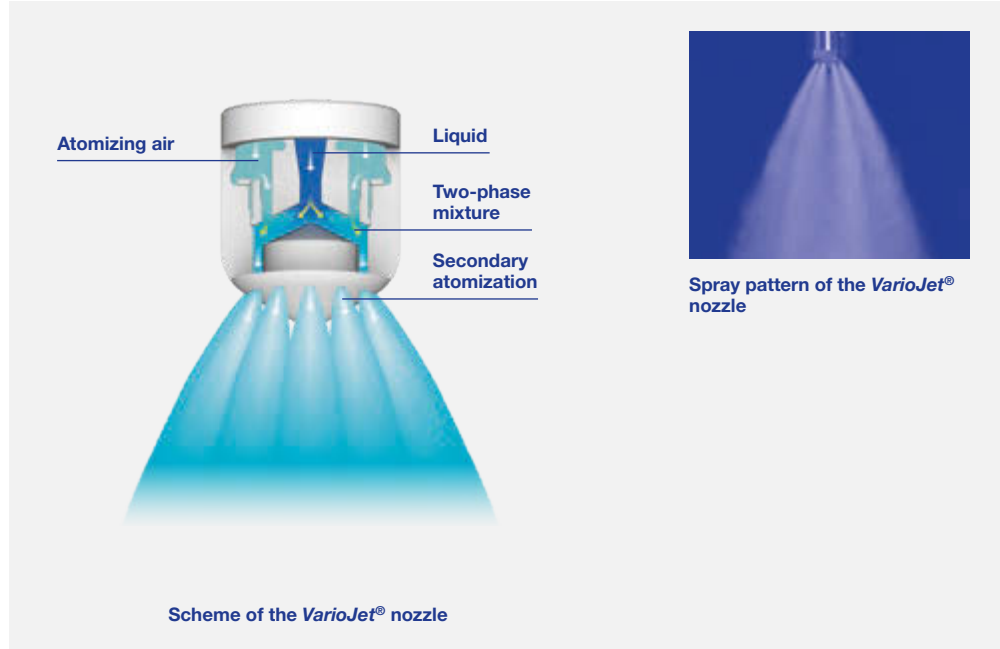

## Use:

- Gas cooling in gas cooling towers as well as gas-bearing pipes (ducts)

## Properties



**Large spray angle**  
(60°, 90°) for good coverage of the cross-section of the duct



**Adjustment of the droplet spectrum**  
by changing the air/fluid ratio



**Clog-resistant**  
thanks to large free cross-sections without internal fittings



**High turn-down ratio**  
up to 20:1



**Low air consumption**



**Typical pressure range**  
Liquid 1–9 bar, g  
Atomizing air 1–6 bar, g

# Laval nozzles

Twin-fluid nozzles for a wide droplet spectrum in special applications



## Lechler Laval nozzles

atomize liquids as a fine full cone. These twin-fluid nozzles work according to the supersonic principle.

A dual-phase mixture is created from atomizing air and liquid in the mixing chamber inside the nozzle. The shape of the nozzle causes this mixture to be accelerated to supersonic speed, resulting in an extremely fine atomization of the droplets.

By changing the air/liquid ratio, the droplet size and the droplet spectrum can be adapted within a wide range. The large free cross sections of the nozzle also allow atomization of viscous or solids-laden liquids.

Choosing the right material prevents wear even where abrasive media are present, and enables use at high temperatures.

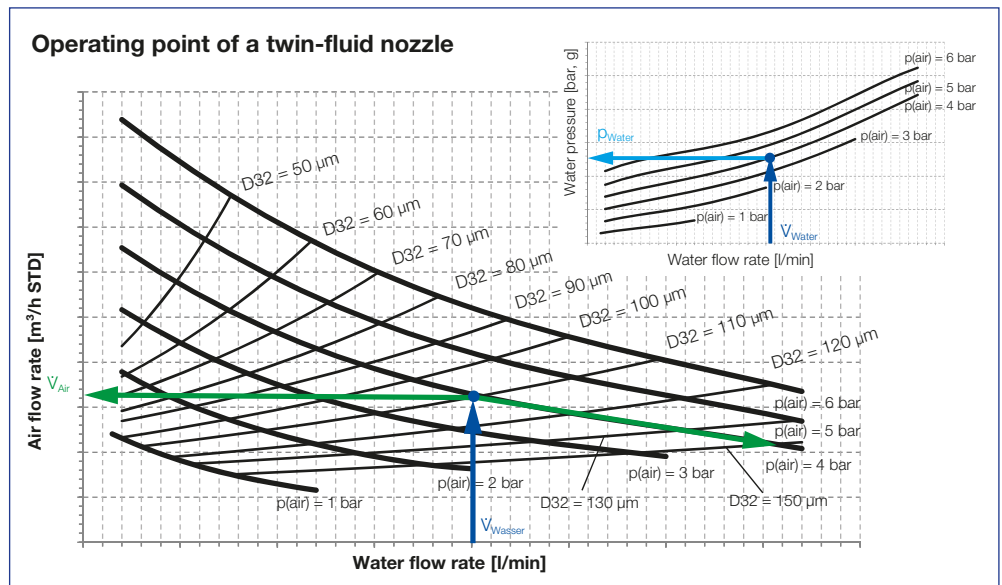
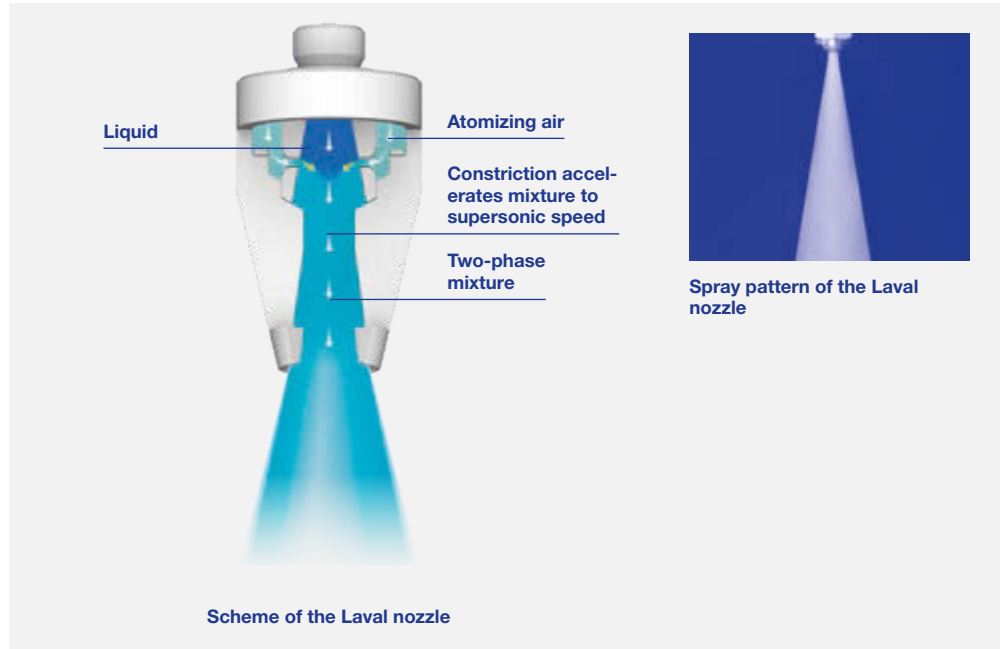

- Use:**
- Gas cooling in gas-bearing pipes (ducts) and medium-sized and small gas cooling towers
  - Injection of solids-laden water
  - Introduction of lime water in the desulfurization process
  - Injection of aqueous ammonia or urea solution for the DeNOx process (SNCR/SCR)
  - Chemical process engineering (spray dryers etc.)

## Properties



**Small spray angle** (15°), suitable for small cross-sections and horizontal ducts



**Adjustment of the droplet spectrum** by changing the air/ fluid ratio



**Clog-resistant** thanks to large free cross-sections without internal fittings



**Very large turn down ratio** of 20:1 (in some cases up to 40:1)



**Very fine droplet spectrum**



**Typical pressure range**  
Liquid 1–6 bar, g  
Atomizing air 1–6 bar, g

# Special twin-fluid nozzles for DeNOx applications

## Laval nozzle

In DeNOx applications with SNCR processes, small Laval nozzles are usually used. These nozzles are characterized by a high discharge velocity, enabling the optimum droplet spectrum to be introduced into the reactor with a great penetration depth.

Our research has shown that the discharge velocity has a greater effect on the denitri-fication process. Moreover, these nozzles without internals are extremely insensitive to clogging and can be precisely controlled.

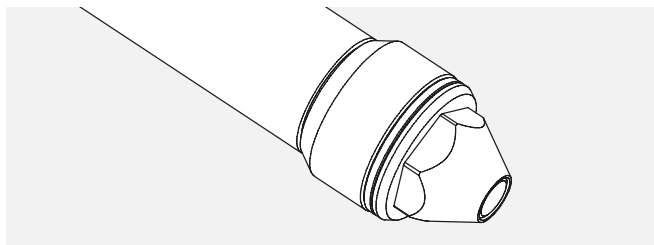

## Special properties



**Small spray angle** (15°), suitable for small cross-sections and horizontal ducts



**Typical pressure range**  
Liquid 1–6 bar, g  
Atomizing air 1–6 bar, g



**Turn-down ratio** of 20:1 (in some cases up to 40:1)



**Very fine droplet spectrum**



**Adjustment of the droplet spectrum** by changing the air/liquid ratio



Spray pattern of a Laval nozzle

**For SCR processes and special SNCR processes there are special nozzles which have been developed to meet the specific requirements. The same principles regarding control and operation apply for all twin-fluid nozzles, irrespectively of the type.**

## Laval flat fan nozzle

The Lechler Laval flat fan nozzle atomizes according to the principle of inside mixing. The air/fluid mixture exits via three outlet holes creating a wide and flat spray with an even better surface coverage.

The droplet spectrum and the pulse of the droplets can be adapted by changing the air/ fluid ratio.

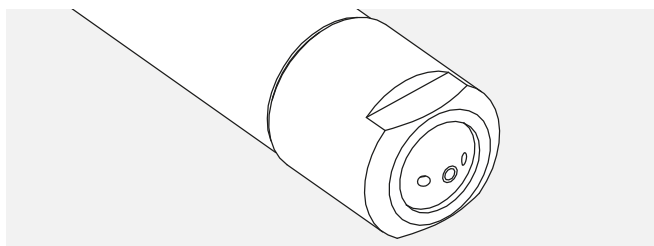

## Special properties



**Wide and flat jet,** spray angle 60°



**Spray alignment possible**



**Turn-down ratio** of over 10:1



**Adjustment of the droplet spectrum** by changing the air/liquid ratio



**Typical pressure range**  
Liquid 1–5 bar, g  
Atomizing air 1–5 bar, g



Spray pattern of a flat fan nozzle

## MasterNOx® for DeNOx processes

The Lechler *MasterNOx*® nozzles are usually used in the non-catalytic denitrification of flue gases (SNCR process). They are usually designed as flat fan nozzles and achieve a high spraying range to make the liquid penetrate as far as possible into the boiler. The

nozzle specially developed for the retrofitting of existing power plants is characterized by a small outer diameter, so that it can fit between the pipes of the boiler wall. It can also have a protective flow of barrier air around it without the need for the pipes to be bent aside.

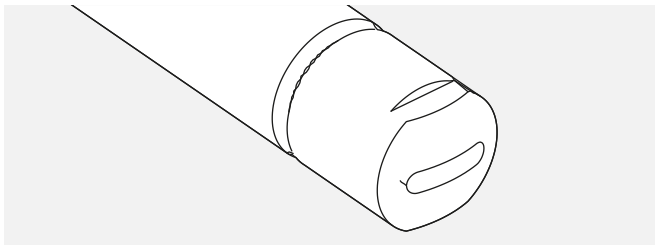

## Special properties



**Spray angle**  
15°, 30°, 60°



**Turn-down ratio**  
of over 50:1



**Typical pressure range**  
Liquid 1–10 bar, g  
Atomizing air 1–6 bar, g



**Adjustment of the droplet spectrum**  
by changing the air/liquid ratio



Spray pattern of a *MasterNOx*® nozzle 30°

## 1AW nozzle

The Lechler 1AW nozzle works according to a newly developed and patented atomization principle. It divides the supplied atomizing air into a primary and secondary air flow. Thanks to the specific in-flow geometry, the secondary air exits through an annular gap causing a very fine atomization in the edge region of the spray.

This twin-fluid nozzle enables finest droplet spectra and shortest evaporation distances while also allowing very good controllability of the flow rate. Cluster heads designed specifically for these nozzles multiply the flow rates and adapt the spray pattern to the requirements at the point of injection.

## Special properties



**Spray angle of the individual nozzle**  
15° as full cone



**Particularly fine droplets** thanks to tertiary atomization



**Turn-down ratio**  
of 10:1



**Design**  
as single or bundle nozzle lances



**Typical pressure range**  
Liquid 1–5 bar, g  
Atomizing air 1–5 bar, g



**Adjustment of the droplet spectrum**  
by changing the air/liquid ratio

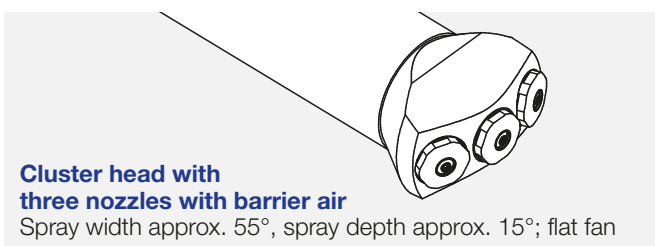
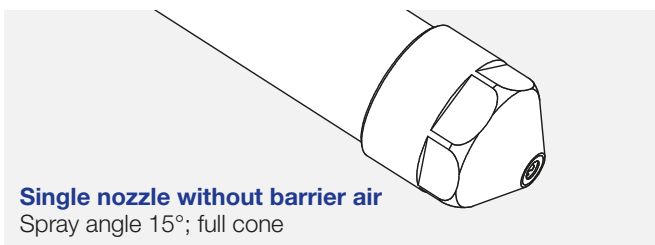

Spray pattern of 1AW nozzles

# Nozzle lances

Highest spraying accuracy in the flue gas duct

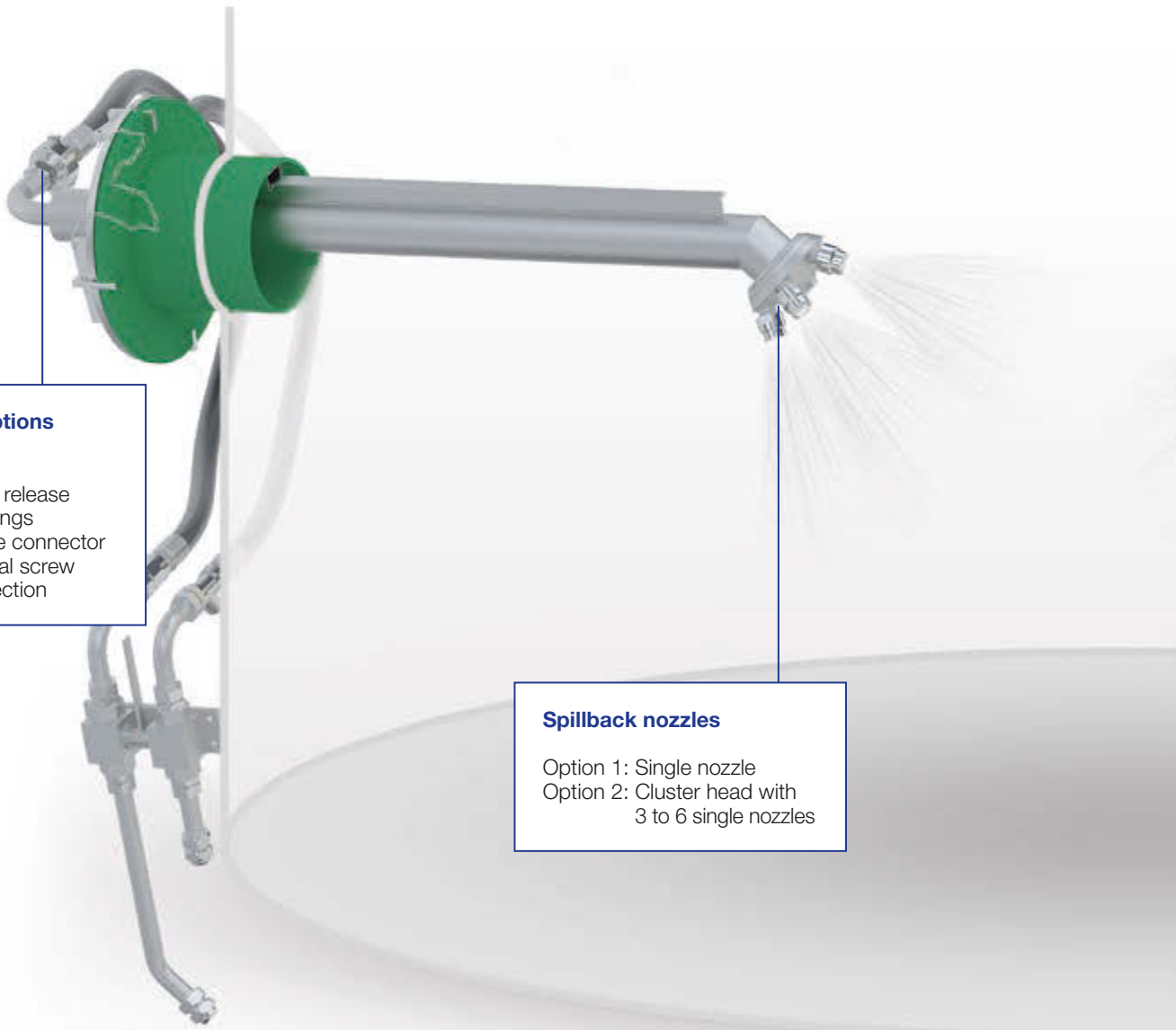

**Connection options  
Accessories**

Option 1: Quick release couplings  
Option 2: Flange connector  
Option 3: Conical screw connection

**Spillback nozzles**

Option 1: Single nozzle  
Option 2: Cluster head with 3 to 6 single nozzles

**Lechler nozzle lances** ensure optimal spray placement and alignment in flue gas ducts. The choice of nozzles and the consideration of local conditions and process-related matters means they can be individually adapted to the respective requirements.

The nozzles themselves have a low-maintenance design and can be quickly cleaned or exchanged with minimal effort.

The robust, high-quality stainless steel construction ensures a high degree of functional reliability. Lances are available in a variety of material to suit specific process requirements.

Lechler nozzle lances are available with many options, including but not limited to:

- Protection tube to increase the service life in case of higher temperatures, high dust loads and aggressive gases, with barrier air as an option

- Wedge flange, standard flange and special flange in accordance with customer requirements
- Guide rail to facilitate lance installation
- Shifting device to change the insertion length – with or without gastight sealing
- Expansion joint or stuffing box for expansion compensation at high temperatures
- Assembly connecting piece with flange connector for welding onto flue gas duct

- Further special customizations including wear protection, insulation, water cooling or coating
- Pre-assembled accessory kits for process media connections (e.g. quick release couplings, shut-off ball valves, strainers)

**Lechler nozzle lances are manufactured in line with ultramodern production processes and according to the state of the art.**



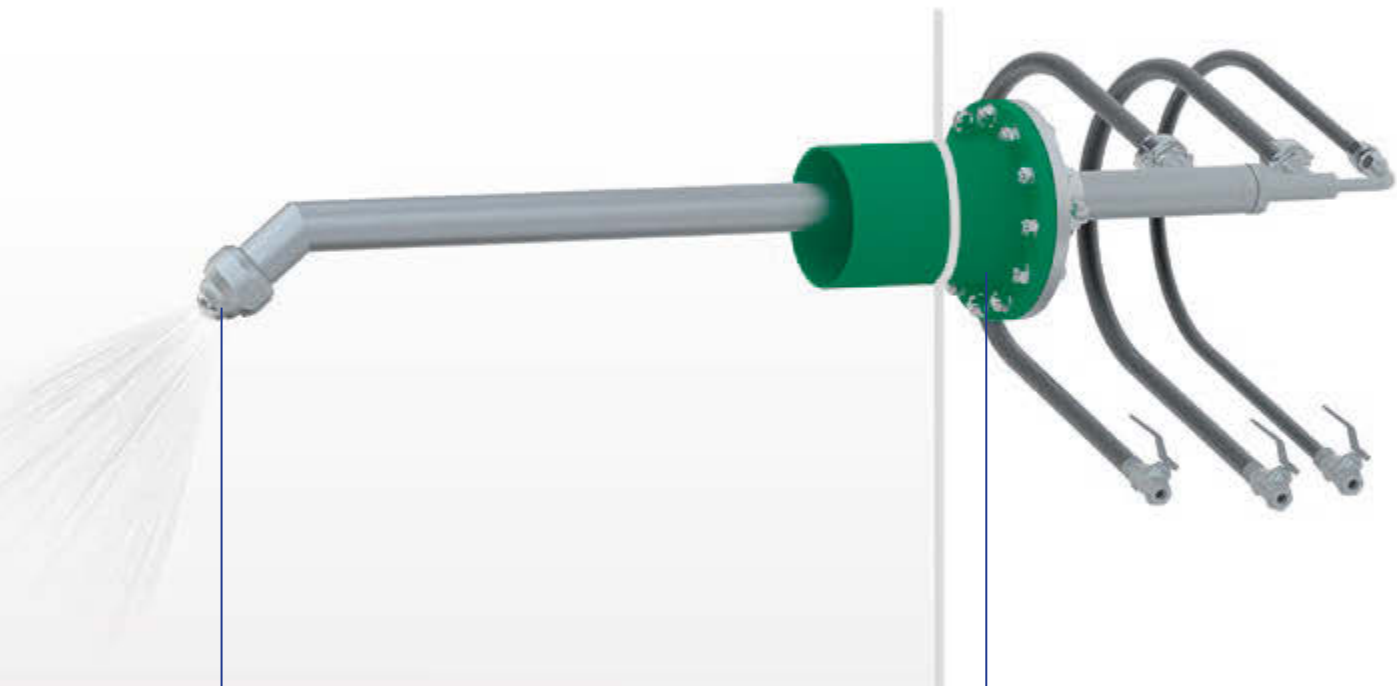

**VarioJet® nozzle**

Option 1: Without protection tube and without protection cap  
 Option 2: With protection tube and with protection cap

**Flange connections**

Option 1: Wedge  
 Option 2: Standard flange e.g. DIN, ANSI etc.  
 Option 3: Special flange according to customer specification

1



2



3



**Material**

Lances are manufactured from stainless steel (316/316L) as standard, but depending on requirements can also be made of chemical and high-temperature resistant materials.

Accessories are available in galvanized steel or stainless steel and the hoses are available in rubber or stainless steel.



**Talk to us**

Each gas cooling tower and flue gas duct is different. Which is why standard solutions do not always make sense. Speak with us and let us work together to find the best solution for your purposes.



# VarioCool® gas cooling system

## For a perfectly tailored solution

**Our valve skid units for regulating the flow rates of water and atomizing air are individual customer-specific solutions. Based on the requirements in each case, our first step is to design an overall concept and select the best components in order to create a perfectly tailored solution.**

### First-class engineering

To perform our engineering, we determine all relevant parameters and define the plant's design. This includes determining the nominal widths and pressure levels as well as designing the pumps and control valves. We draw up the P&I diagram and make detailed equipment and signal lists as an option. Of course, the project is fully documented to ensure that technology and processes can be quickly traced even after years of use.

### High-quality components

An exact knowledge of the characteristic properties of our nozzles is key here. For only a complete system that is coordinated to how the nozzles function and operate will ensure smooth and economical operation of the gas cooling system. The service life of the products used is key to a power plant's profitability. Unexpected failures can quickly lead to plant stoppages and costly production outages. Which is why we fit our valve skid units with high-quality components from well-known manufacturers as standard and the most important functional components are even realized in redundant design.

The components are interconnected with pipes and mounted on a stable base frame with eyelets for crane transportation, at the same time ensuring that all components for operation and maintenance are arranged in an easily accessible manner.

### Tested quality

The design (e.g. dimensioning of nominal widths) and production are in line with the latest state of the art and comply with all relevant standards. They are equally subject to the Lechler quality management system certified to DIN EN ISO 9001, as is the final acceptance. Before delivery, the valve skid unit undergoes a pressure and tightness test and is checked by our experienced engineers. This will avoid any problems during commissioning.

### Control concept from the nozzle specialist

Numerous installations of VarioCool® systems, years of commissioning experience, plus expertise in nozzle technology all contribute to the constant improvement and optimization of Lechler control systems. By installing a control solution from Lechler you will benefit considerably from this wealth of experience. The flexible and fully automatic concept can be perfectly adapted to your process. You will have start-up and shut-down scenarios and dynamic process conditions under perfect control with our solution.



## Option packages for our VarioCool® valve skid units

### Electrical wiring of the components:



#### Junction box

All components except the pump motors are wired to a junction box within the valve skid unit.

This assures that the customer has a central connection point for all electrical components and measuring devices for further processing in the higher-level control.

#### Control cabinet with complete PLC

All components including the pumps are wired to a control cabinet. The control cabinet is integrated into the base frame of the valve skid unit.

The complete injection control is tested in accordance with valid electrical standards and regulations and allows all relevant process parameters to be visualized over a control panel on the control cabinet.

Specific configuration and extensive testing make commissioning much faster. Communication and the exchange of signals (setpoint, plant status, error messages) with the customer's logic system is carried out via PROFIBUS or PROFINET.

The control has several modes of operation such as automatic mode and manual mode for tests during plant downtimes. In the event of faults, our engineers can quickly perform a remote diagnosis via the installed modem without the need for an on-site visit.

# VarioCool® gas cooling system

For a perfectly tailored solution

## Extended scope of delivery



### Ring mains

Ring mains are usually used to supply the lances. Lechler supplies ring mains and headers together with the corresponding brackets for welding onto the flue gas duct. Accessories such as pressure transmitters and manometers plus the appropriate connections for the lances and supply lines are also included in the scope of delivery.

### Purge air connection

In order to increase the injection turn-down ratio, individual lances or lance groups can be connected or disconnected. If the disconnected lances are in the flue gas duct, the rest of the fluid should be purged. Vaporization and deposits in the lance can be prevented in this way.

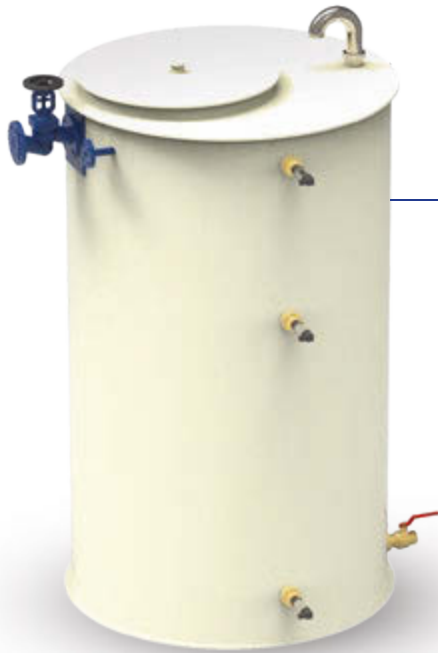

### Water tank

A water tank made of steel or plastic serves as a reservoir for the valve skid unit and guarantees injection operation for a certain period of time in the event of the water supply failing. Its size is adapted to the injection quantity. The components for tank filling and level monitoring are included in the scope of delivery.



### Barrier air fan

In order to protect the nozzles and lances from dust deposits and/or high temperatures, barrier air is frequently applied to them. For this purpose, Lechler supplies fans geared to the specific application with various optional attachments such as a throttle valve, suction filter and silencer.



### Temperature measurement

For a constantly regulated outlet temperature, it is very important for the response characteristics of the temperature sensors to be adapted to the ambient conditions. Lechler provides the appropriate thermometers and assists you in defining the installation position.



### Talk to us

Do you require an option that is not listed? Or are you having planning issues? No problem. Tell us what your requirements are. We will find the appropriate solution and ensure a seamless integration.

# Lechler Online Cleaning (LOC<sup>®</sup>)

## Cleaning-in-Place system for twin-fluid nozzle lances

In the semi-dry flue gas cleaning processes used in power plants, an alkaline washing suspension, usually lime slurry, is injected into the hot flue gas in spray towers. The droplets injected by twin-fluid nozzles are evaporated by the transferred heat. At the same time, pollutants such as SO<sub>2</sub>, HCl and HF react with the reactants in the washing fluid.

The washing suspension frequently causes damaging deposits and blockages in the nozzles, nozzle lances and pipelines. In the past, reliable long-term plant installation was often not possible without regularly dismantling and cleaning the nozzle lances. Good process results frequently came at the cost of high maintenance effort.

**The Lechler LOC<sup>®</sup> Cleaning-in-Place system eliminates the need for complex disassembly, unnecessary downtimes and personnel costs.**



Spray absorbers/dryers



Ring mains with LOC<sup>®</sup> unit



LOC<sup>®</sup> reference installation with maximum equipment configuration

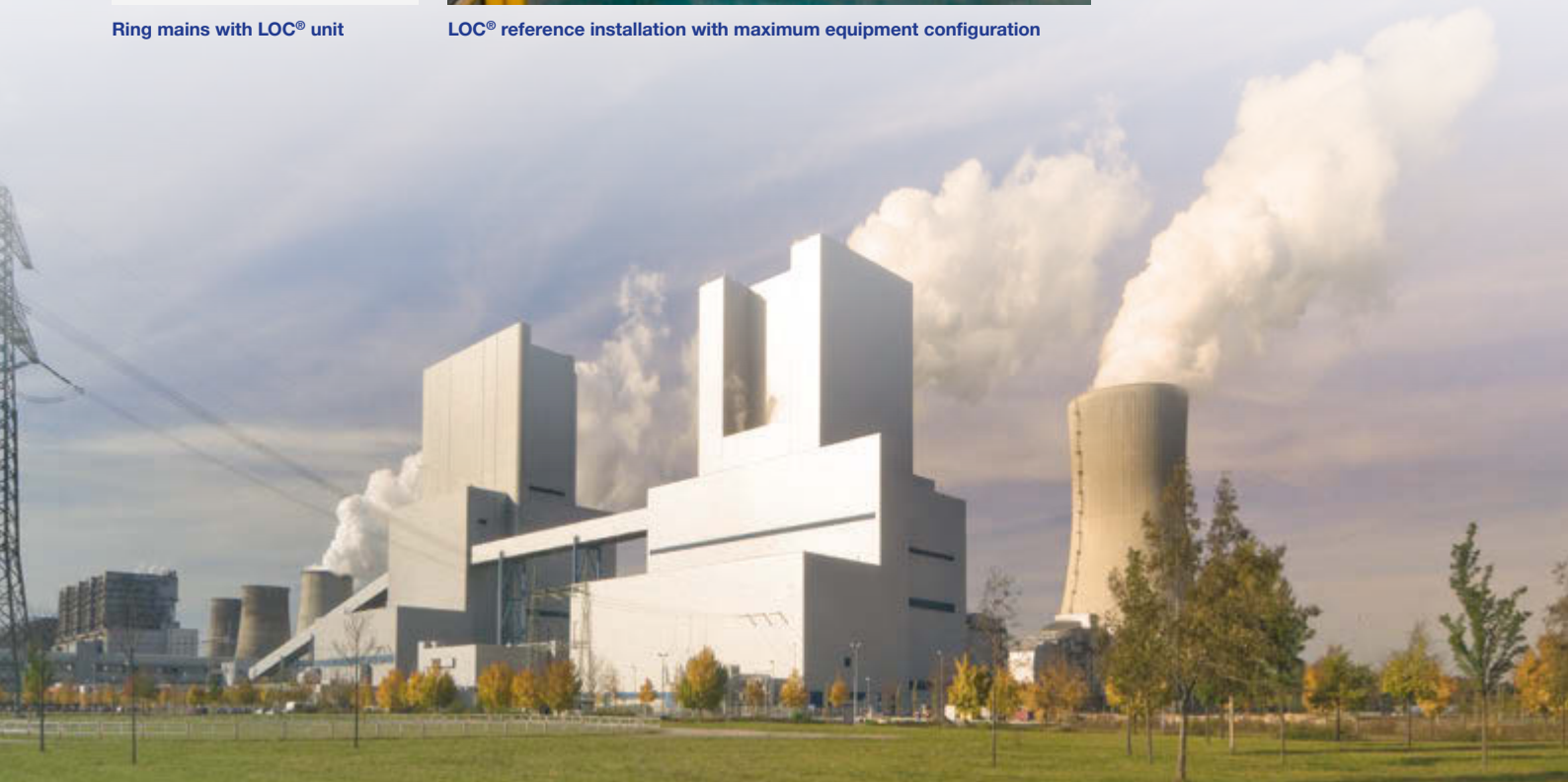

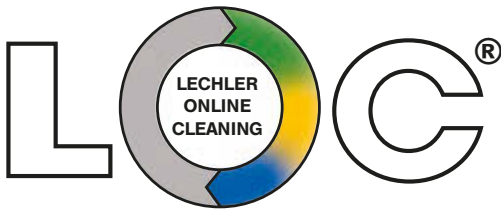

## LOC® makes your plant more economically efficient

Lechler offers an online cleaning system tailored to the respective application which allows reliable continuous operation and inexpensive cleaning of the nozzle lances.

The nozzles are made of wear-resistant hard metal and have been optimized for atomizing suspensions. The individual lances are cleaned cyclically during ongoing operation using precisely metered quantities of cleaning agents. In many cases, minimum use of diluted citric acid (10%) and compressed air is sufficient for reliable cleaning while at the same time ensuring compliance with the process limit values.

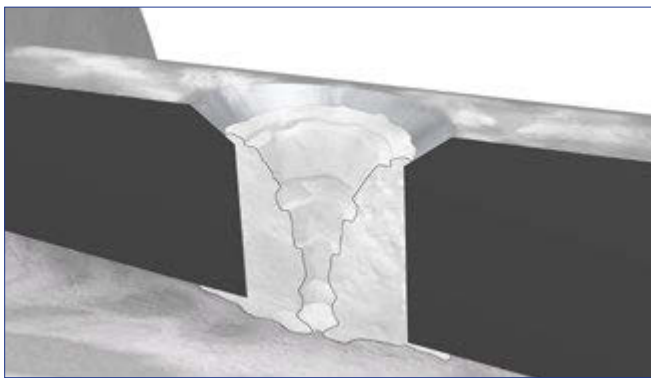

Blocked air holes

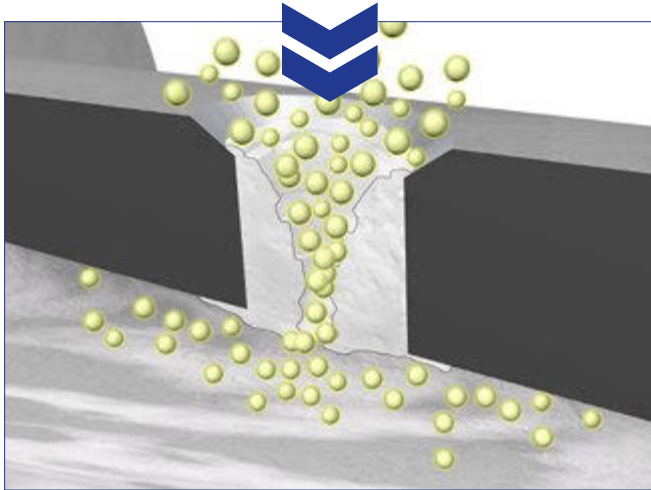

Cyclical cleaning with citric acid doped in compressed air

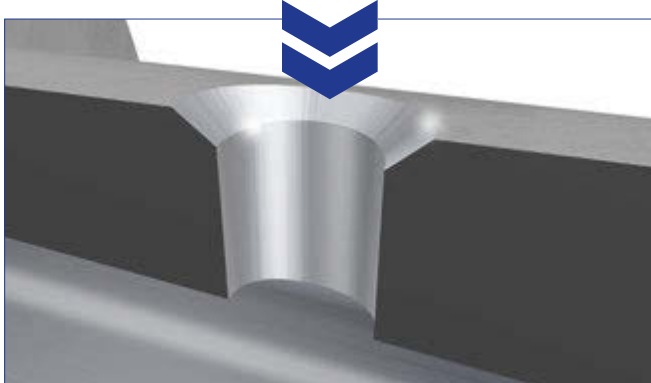

Cleaned nozzle



A visible difference:  
Nozzles before and after LOC® treatment

## Advantages

- High availability of the spray reactor/dryer
- Uninterrupted operation
- Minimum maintenance effort
- Low costs through the controlled use of cleaning agents

## Talk to us

Lechler Online Cleaning (LOC®) is a tailor-made solution. The better we know your requirements and operating conditions, the more efficiently your processes will run. Let's talk to each other – about efficiency, cost savings and success.



# ENGINEERING AND SERVICE

## Our experience for your success

With our experienced engineering team, you have a competent contact for your project at all times – from technical design and detail engineering to commissioning and replacement of spare and wearing parts. You will benefit from direct contact and fewer communication channels to enable smooth completion of your project.

## Exclusive solutions

Lechler offers a system solution tailored to your application and plant-specific conditions. We use only high-quality components from renowned manufacturers for our valve skid units. If you choose a system with a control, you will get a complete solution for your gas cooling and conditioning requirement from a single source.

## Reliable service is part of our agreement

Lechler is Europe's No. 1 nozzle manufacturer. A key factor for this success is our service. For even after your system has been delivered, you are in good hands with Lechler. We offer a worldwide commissioning service provided by employees with many years of experience. A signal and performance test ensures optimal system operation taking all operating and safety aspects into consideration. An important point of commissioning is also the detailed briefing of operating and maintenance personnel in the operation and maintenance of the plant.

We are your competent partner who will provide you with assistance to solve your problems. Our on-site service for preventive maintenance ensures continuous operation. We will be more than happy to draw up a maintenance contract tailored to your needs.

## From digital to real

Each individual design of gas cooling and conditioning systems is based on innovative software. CFD calculations are used for flow optimization. Using a 3D tool, we identify the optimum liquid distribution in the duct together with the necessary lance arrangement.

Our drawings are created using state-of-the-art design engineering software.

## Extensive documentation

Our nozzle lances and systems are designed and manufactured in line with the current standards and regulations. New plants are always delivered with project-related documentation containing all relevant information for commissioning, operation and maintenance. Lechler will also provide a verbal description of the function and control concept where desired.

## Future-proof

Lechler systems are built to withstand harsh conditions and enable reliable and long-term operation. But we too have to lend to the extreme process conditions in the power plant industry. Which is why it is all the more important to us to have a guaranteed long-term supply of spare parts for wearing parts – worldwide. With our global network of representatives, we offer a worldwide platform for contact and advice. You will find your competent contacts on the Lechler website.





# CFD Analysis

## Flow optimization with computational fluid dynamics

### Fluid Dynamics simulation as a process optimization tool

**For us, perfection is not just a promise, but is based on calculation of computational fluid dynamics (CFD).**

No matter what the spray application, the goal is always to achieve the maximum effect with the minimum possible use of material, spray media and energy. It is therefore essential to have a detailed understanding of how spray mist is formed and propagated. This is made possible by computer-aided simulation of the flow processes (CFD – computational fluid dynamics) of one or more substances in static or dynamic environments taking into account heat and mass transfer.

These simulations incorporate our many decades of know-how from the field of nozzle development. Initially, CFD was only an internal tool which helped us to develop a desired nozzle more quickly and precisely. The completion of our high-performance cluster with a processing power of around 8,500 GFlops means that we can now offer our know-how as a service. We simulate nozzle applications and processes individually for your environment and your requirements. So that your processes also run perfectly in real life.

### Our services:

- Calculation of the flow field including pressure losses with one or more flowing media in pipes and fittings
- Spray propagation including heat and mass transfer with the surrounding gases under practically all conceivable ambient conditions
- Calculation of internal nozzle flows and prediction of the spray pattern, water distribution and spray characteristics down to droplet sizes in the near-nozzle range

### Your advantages:

- Maximum efficiency as regards:
  - the use of expensive consumable media
  - geometric dimensions of the overall spray process
- Through targeted optimization of:
  - nozzle selection
  - nozzle operating point (taking into account your pumps, compressors and blowers)
  - liquid distribution
  - droplet sizes
  - inflow and outflow of your process gases in relation to the spray process (with the aim of achieving uniformity and reducing pressure losses)



**You can't just guess at perfection, it must be precisely calculated**

The flow behavior of gases is significantly determined by the geometry of the environment. By applying computer simulation using computational fluid dynamics (CFD), our specialists can detect unequal gas distributions as well as turbulence. Depending on the specific conditions, these issues can be resolved in different ways. Installing baffles, perforated plates or even repositioning nozzles can be simulated to achieve the desired flow characteristics. The result of optimized gas flow via CFD can significantly reduce energy and/or material requirements.

**Optimization of the gas flow in the gas cooling tower**

**Benefits:**

- Efficient cooler operation thanks to lower atomizing air consumption and/or lower connection pressures at the nozzle lances
- Wet ground avoided as well as possible caking on the inner wall of the cooler
- Stable process in various load cases



**Optimization of SNCR process – best possible selection and placement of nozzles**

**Benefits:**

- Reactive ammonia vapor is present where the gas containing nitrogen (NOx) flows
- Avoidance of unnecessary NH<sub>3</sub> slip, meaning efficient use of the ammonia solution
- Best possible reduction rates of nitrogen oxides

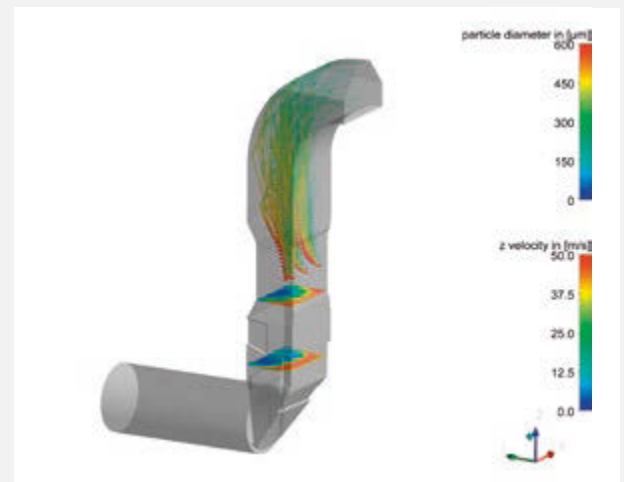

**Design and continuous optimization of our products**

**Benefits:**

- Optimal atomization effect
- Efficient use of the connected atomization media
- Reduction of the required nozzle connection pressures
- Individual nozzle development in the shortest time

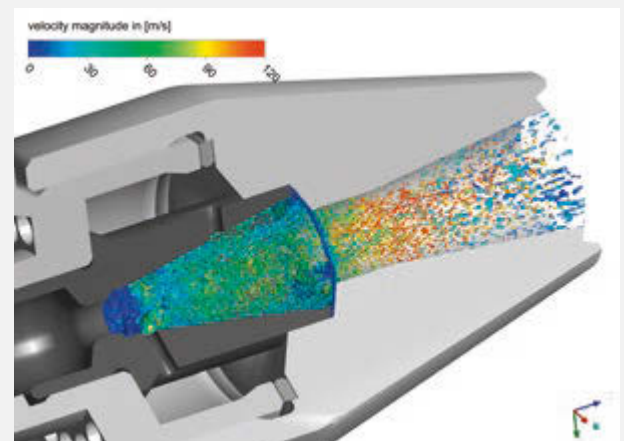

# NOZZLES FOR FLUE-GAS DESULFURIZATION

**Flue-gas desulfurization in power plants requires nozzles that guarantee precise long-term operation and are also to withstand extremely aggressive ambient conditions. Lechler has developed atomizing nozzles made of ceramic materials, e.g. from SIC, SISIC or ReSIC, for these applications.**

Lechler TwinAbsorb® nozzles ensure efficient flue gas cleaning and reliable SO<sub>2</sub> separation. Their improved efficiency, reduced operating costs as well as low maintenance costs make TwinAbsorb® nozzles the first choice for power plant operators for both process and economic reasons.

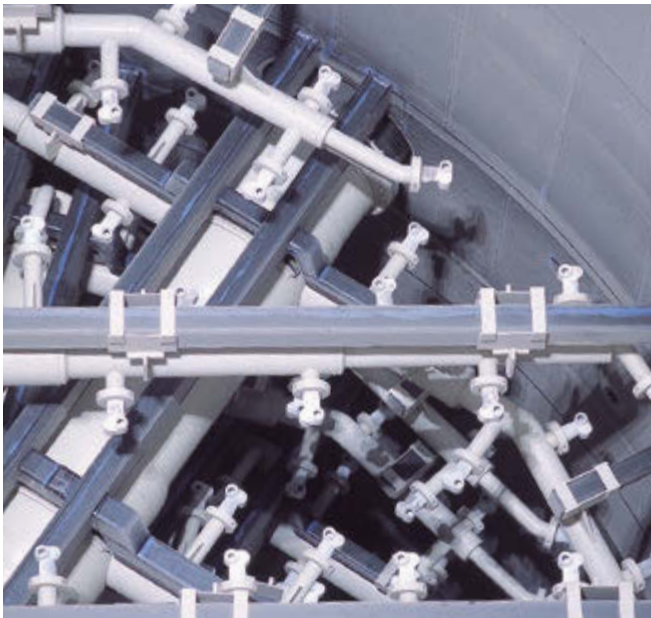

## TwinAbsorb®-EV Equilateral Double Full Cone Nozzle

The proven equilateral double full cone nozzle TwinAbsorb®-EV generates two full cones by using one single supply.



### Advantages

- Provides smaller Sauter diameter (SMD  $d_{32}$ ) caused by dual cones.
- Particularly advantageous not only for high flow rates per nozzle.
- Improved mass transfer caused by increased specific surface area.
- Supports an even gas distribution over the scrubber cross-section.
- Rotation impact onto the gas flow is compensated within the nozzle.
- Better coverage of scrubber wall section.
- Reduced slurry loss at the scrubber wall in comparison to hollow cone nozzles.
- Reduced stress at scrubber wall in comparison to hollow cone nozzles.
- Reduced torque onto the pipe branches.
- Keeps the advantages of Lechler tangential flow full cone nozzles
  - completely self draining
  - large free passages
  - non-clogging designed



## TwinAbsorb®-EH Equilateral Double Hollow Cone Nozzle

The proven equilateral double hollow cone nozzle TwinAbsorb®-EH generates two hollow cones by using one single supply.



### Advantages

- Provides smaller Sauter diameter (SMD  $d_{32}$ ) caused by dual cones.
- Particularly advantageous not only for high flow rates per nozzle.
- Extra overlapping area for highly intensive secondary atomization.
- High efficient generation of new stimulated reaction surface without additional energy input.
- Increased turbulence within the drop achieves reactivity of reaction surface.
- Improved mass transfer caused by increased specific surface area.
- Rotation impact onto the gas flow is compensated within the nozzle.
- Better coverage of scrubber cross-section.
- Reduced torque onto the pipe branches.
- Keeps the advantages of Lechler tangential flow hollow cone nozzles
  - completely self draining
  - large free passages
  - non-clogging designed



# NOZZLES FOR FLUE-GAS DESULFURIZATION

## TwinAbsorb®-V Double Full Cone Nozzle

The proven double full cone nozzle TwinAbsorb®-V generates two counter rotating full cones by using one single supply.



### Advantages

- Improved mass transfer caused by higher relative velocity of liquid to flue gas.
- Rotation impact onto the gas flow is compensated within the nozzle.
- Increased turbulence within the drop for highly active reaction surface.
- Increased residual time of drops during the process.
- Duplication of hydraulic spray level in comparison to single spray nozzles.
- Reduced pressure loss in case of counter current gas flow.
- Reduced slurry loss at the scrubber wall in comparison to hollow cone nozzles.
- Better coverage of scrubber wall section.
- Provides smaller Sauter diameter (SMD  $d_{32}$ ) caused by dual cones.
- Reduced stress at scrubber wall in comparison to hollow cone nozzles.
- Reduced torque onto the pipe branches.
- Keeps the advantages of Lechler tangential flow full cone nozzles
  - completely self draining
  - large free passages
  - non-clogging designed



## TwinAbsorb®-H Double Hollow Cone Nozzle

The proven double hollow cone nozzle TwinAbsorb®-H generates two counter rotating hollow cones by using one single supply.



### Advantages

- Improved mass transfer caused by higher relative velocity of liquid to flue gas.
- Rotation impact onto the gas flow is compensated within the nozzle.
- Intensive secondary atomization results in an increased surface for faster mass transfer.
- Increased turbulence within the drop for highly active reaction surface.
- Increased residual time of drops during the process.
- Supports an even gas distribution over the scrubber cross-section.
- Duplication of hydraulic spray levels in comparison to single spray nozzles.
- Reduced pressure loss in case of counter current gas flow.
- Provides smaller Sauter diameter (SMD  $d_{32}$ ) caused by dual cones.
- Reduced torque onto the pipe branches.
- Keeps the advantages of Lechler tangential flow hollow cone nozzles
  - completely self draining
  - large free passages
  - non-clogging designed



**Process-oriented nozzle configuration**

- Supports better gas distribution
- Highly efficient secondary atomization
- Improved mass transfer
- Swirl compensation

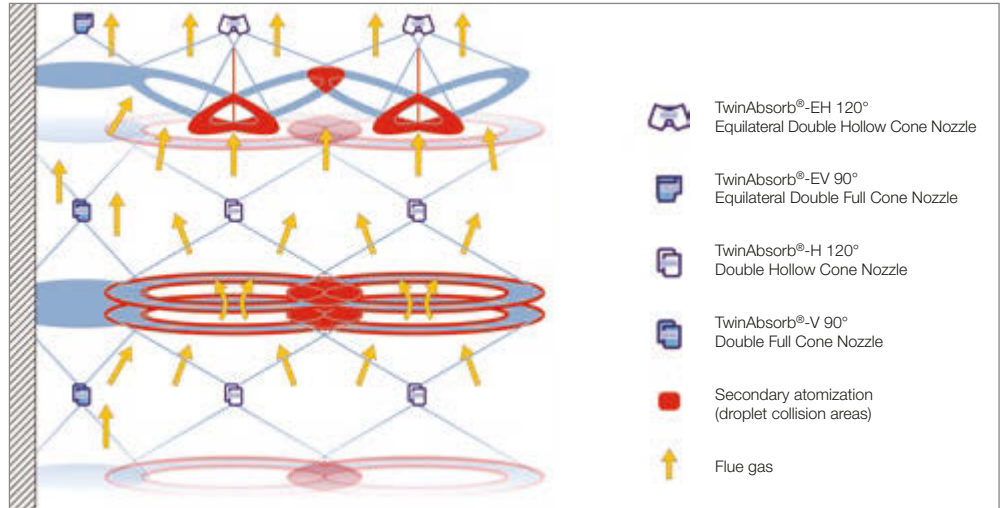

In addition to the TwinAbsorb® series, Lechler also offers a comprehensive range of nozzles for flue gas desulfurization in a wide range of designs and materials that are exactly tailored to your specific application.



**Twin4Absorb**

Twin4Absorb nozzles are a further development of the TwinAbsorb® nozzle series. Four overlapping spray cones generate additional jet collisions and thus a more active reaction surface. Thanks to the enhance spatial distribution, the Twin4Absorb nozzles are ideal for optimizing existing scrubbers.



Nozzles made of SIC



Nozzles made of SISIC



Helix nozzles made of SISIC/ReSIC



Helix nozzles made of Stellite



**Talk to us**

Are you not sure which configuration best meets your requirements? We will gladly advise you. Just give us a call.

# LECHLER DROPLET SEPARATORS

Keep it dry and eliminate mist

The introduction of wet flue-gas desulfurization in Germany is inconceivable without Lechler. As a partner to plant builders, we have made a crucial contribution to success in this area with our development work. The result is nozzles made of highly wear-resistant and corrosion-resistant silicon carbide and droplet separator systems that meet the highest process engineering demands.

Lechler droplet separators are optimally designed for the droplets produced during scrubbing and thus achieve maximum separation levels.

## Task:

- Removal of sulfur compounds
- Protection of downstream installation components
- Reduction of operating costs

## Advantages:

- Modular system design
- Highest degrees of separation for large liquid quantities
- Separation of small droplets
- Compact design even for high gas speeds
- Low pressure losses
- More uniform flow distribution
- Use also with high solid particle quantities
- Cleaning during ongoing operation
- Delivery of an overall concept
  - Nozzles for desulfurization of flue gases
  - Droplet separator systems
  - Integrated cleaning systems for droplet separators

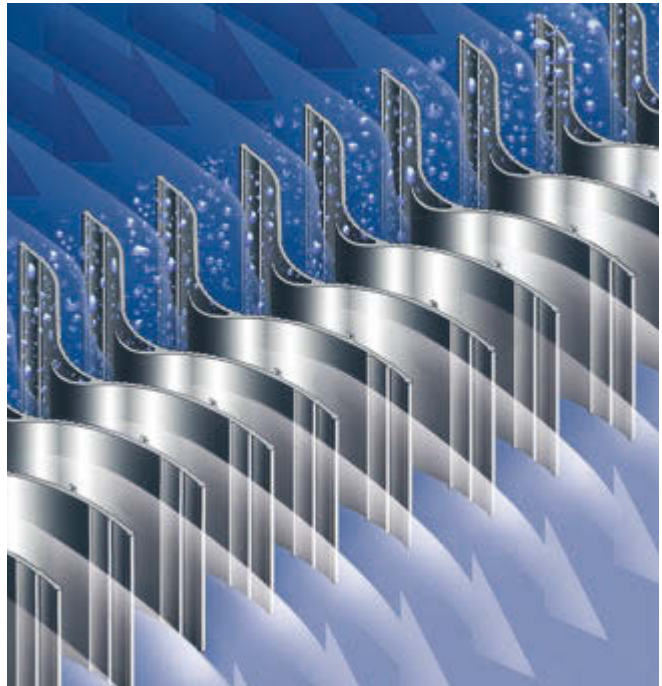

## Talk to us

Do you know your process but are not sure which droplet separator is best suited for your purposes? No problem. Based on your individual requirements, we will choose from a finely graded range of vane profiles with single or multiple deflection.



In order to design and plan droplet separators, it is necessary to be familiar with the operating and performance data of the separation systems. An in-depth technical understanding of the processes in each application is also required. Know-how about droplet formation and droplet movement in a gas flow is essential to ensure fault-free operation of a droplet separator. For more than 100 years now, we have worked on detection, measurement and definition of droplets. It is therefore not by chance that Lechler nozzles and Lechler droplet separators are now considered integral elements in process engineering.

Corresponding to the flow direction, Lechler high-performance separators are differentiated based on horizontal and vertical gas flow. Separators are also realized for oblique gas flow under certain conditions. The choice of flow direction depends on the individual process or plant design. Lechler offers a suitable solution for all installation situations.

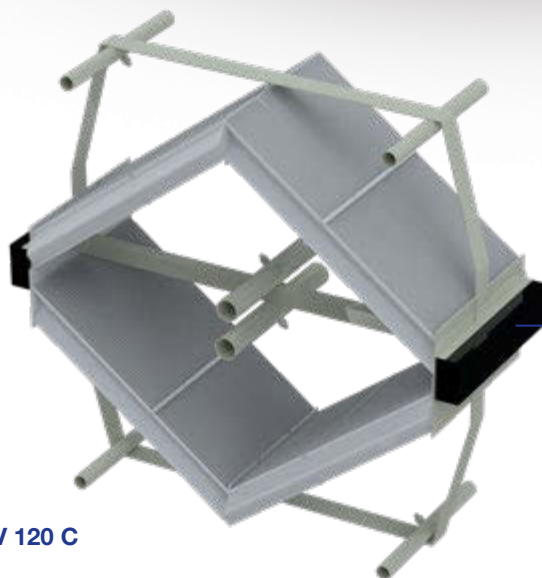
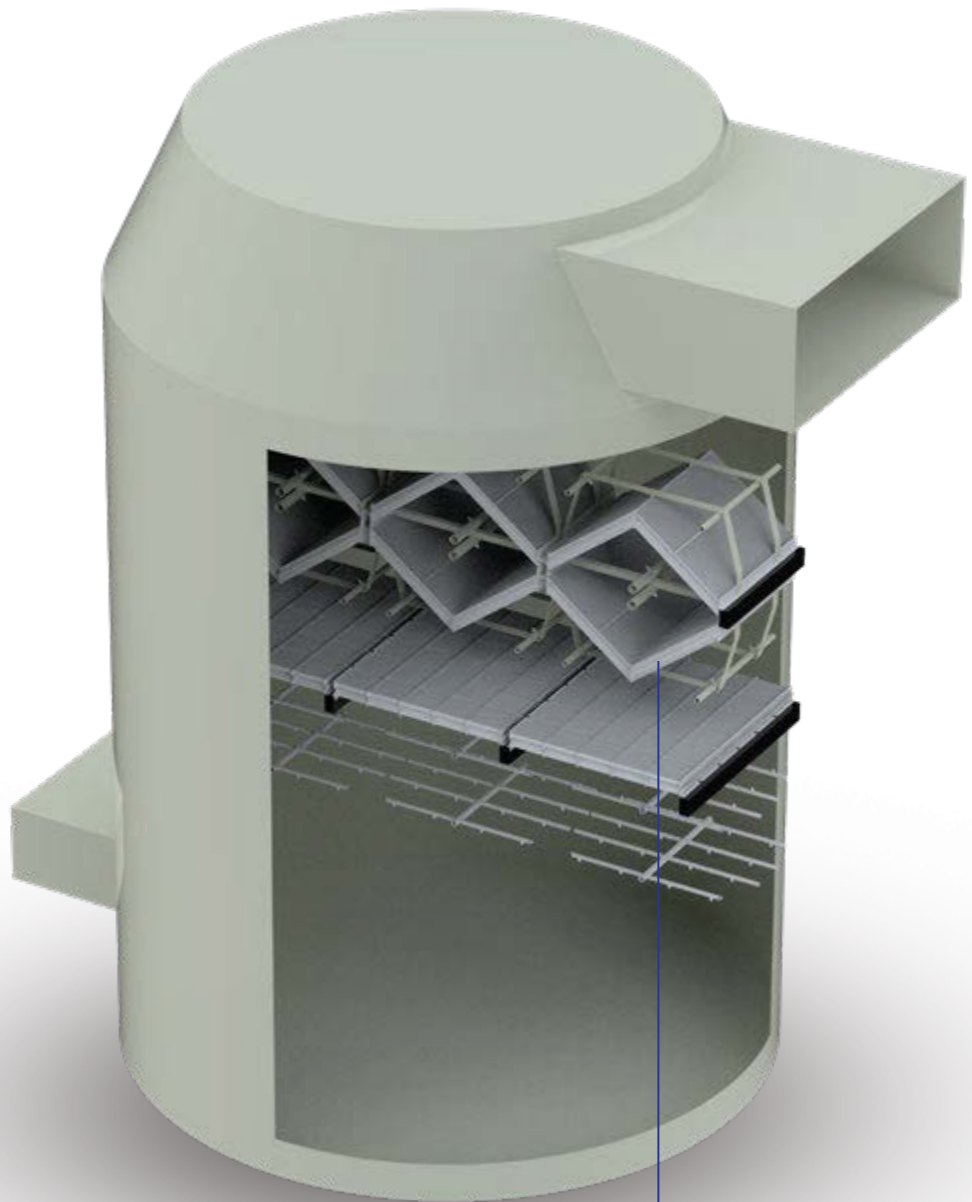

LTV 120 C

# LECHLER DROPLET SEPARATORS

Keep it dry and eliminate mist

The LTV 120 droplet separator for vertical gas flows is available in different designs and also with multiple stages. Integrated cleaning systems with highly efficient Lechler cleaning nozzles permit continuous operation and reduce the risk of clogging. The angled installation position allows reliable removal of the separated liquid even at high gas speeds.

## LTV 120 AA

2-stage droplet separator system with integrated cleaning system for installation on two levels.



## LTV 120 C

2-stage droplet separator system with integrated cleaning system for installation on one level. This system is optimized for restricted installation spaces.

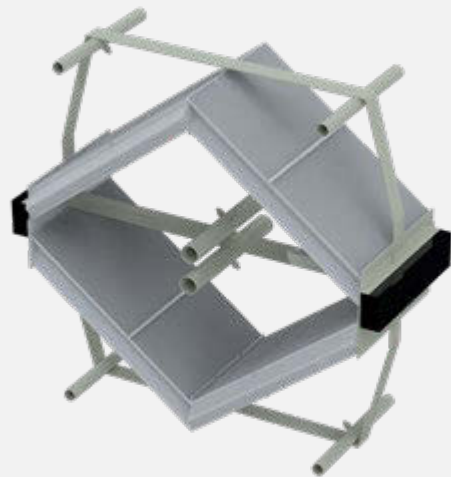

## LTV 120 CR

3-stage droplet separator system with integrated cleaning system for installation on two levels. The first separator stage consists of horizontally arranged pipes for pre-separation and flow optimization.



## LTV 120 A + LTV 400

2-stage droplet separator system with integrated cleaning system for installation on two levels. The first separator stage consists of the LTV 400 as a flat separator level.



The different droplet separator systems can be combined with each other, depending on individual requirements in relation to efficiency and space.

### LTV 400

The LTV 400 is a universal separator system. Thanks to intensive optimization of the profile contour, the LTV 400 achieves high separation values even without additional drainage aids for the separated liquid. The resultant smooth profile surface has a very low fouling tendency and can be cleaned very easily. The LTV 400 can be realized with one or multiple stages and is available with or without cleaning system.



### LTV 271

The LTV 271 is a proven, widely used separator system. It also impresses with its straightforward handling and easy adaptation to the existing installation space. The use of our optional "Fix-Clip" connectors prevents packages from slipping.



### LTV 300

The LTV 300 is characterized by high separation performance – also for very fine droplets – and an exceptionally high hydraulic load capacity. The special profile geometry and angled installation position permit reliable draining of the separated liquid.



### LTH 100

The LTH 100 for horizontal gas flows is characterized by extremely flexible application and combination possibilities. Low pressure loss, high hydraulic load capacity as well as a low fouling tendency make the LTH 100 a universal droplet separator system that has proven itself over the course of many decades.





# MEASURING TECHNOLOGY HOW OUR RESOURCES HELP US ACHIEVE PRECISION

## The basis for precision nozzle development

At Lechler, exact measurements have long been the basis for clearly defined spray characteristics. The data obtained in our laboratories form the foundation for any development and make it easier for our customers to choose nozzles for specific applications. This saves time, lowers costs and provides planning security.

## Advanced technology

We have further expanded our research capacities by opening our own Development and Technology Center.

A highlight here is a laser-assisted phase doppler anemometer. As one of the most modern optical measuring procedures, it measures the velocity and the diameter of spherical droplets simultaneously and without contact. Using the data obtained, spectra can be reliably derived for particle size distributions and velocities.

## International cooperation

We at Lechler value the importance of international cooperation. For this is often what opens up new perspectives on a problem. In addition, cooperation offers us the possibility of testing nozzles in very special test environments and of discovering new use scenarios in this way.

Measurements range from tiny water droplets in the micrometer region to very large droplets of around 8 millimeters. These are performed with a high temporal and spatial resolution.

Individual positions in the spray can be automatically approached and measured with extremely high accuracy – in x, y and z directions.



## Our unique selling proposition: Practice-based knowledge

Since it was founded, Lechler has stood out for its development of new technologies. In more than a century we have successfully filed a large number of patents. Starting with the "Centrifugal Sprayer" from 1893 and going up to state-of-the-art technologies of the 21st Century. We will continue this proud tradition into the future, and our new technical center will be key to doing so. After seven years of construction, the Lechler Development and Technology Center was opened in the summer of 2016. Since then it has offered everything nozzle developers dream of on a surface of over 600 m<sup>2</sup>. In addition to extensive measuring facilities, state-of-the-art test benches with a wide range of pump performances are available to measure and investigate sprays, from microfine mist to fuller sprays with varying jetting characteristics.

# MEASURING TECHNOLOGY THE LECHLER DEVELOPMENT AND TECHNOLOGY CENTER

## Our measurement range:

- Precise and reproducible measurement of droplet sizes and speeds in sprays
- Measurement of complete sprays or of local positions in a spray
- Documentation of the spectra for particle size distribution and velocities
- Determination of the Sauter mean diameter and of many other variables relevant for process engineering
- Measurement of very dense sprays using state-of-the-art laser technology
- Measurement of tiniest droplets in the  $\mu\text{m}$  region and measurement of very large drops of up to 8 mm
- Measurement of droplet velocities up to 200 m/s
- High temporal and spatial resolution
- Positions in the spray can be automatically approached and measured with extremely high accuracy – in a 3-dimensional space in x, y and z directions
- Very large measuring range allows measurement of very wide particle spectra
- The size and velocity of each individual droplet is detected
- Error-free results in accordance with ISO 9001
- Spray characteristics over area mapped in 3D
- Detection of positive and negative velocity components

## Measurement validation of our calculation models taking the example of a gas cooling tower

### Key figures of our experimental cooler with industry partners:

- Approx. two megawatts of thermal performance
- Use of single-fluid and twin-fluid nozzles under the most realistic conditions possible
- Flexible variation of inlet and outlet temperatures
- Monitoring of droplet sizes and numbers in several levels
- Detection of the evaporation rates of injected sprays
- Use of more than 50 sensors of different kinds for the precise detection of all operating parameters



## QUALITY WITH A SYSTEM

Lechler products are used in a wide variety of sectors and applications.

Which is why the products' requirements are often very specific to certain applications. We define the term "quality" as the extent to which our products fulfill our customers' individual requirements.



We are certified according to internationally recognized standards. Conscientious working and constant quality controls have always been carried out at Lechler, from materials receiving, development and production right through to shipping. So that our products keep what we promise in their daily use.



### Talk to us

Your requirements are the first step towards a solution. We are more than happy to help you solve your individual tasks. Tell us your objectives and we will take care of the solution. If the solution is not yet available, we will tailor-make one for you. That is our promise.

# FOR YOUR QUESTIONS

## QUESTIONNAIRE

Nobody knows your process and requirements better than you. Your knowledge is critical to us in order to find the optimal nozzle for your application.

Simply send us the completed questionnaire or enter your information online.



Data collection sheet for design of a gas cooling system

[www.lechler.de/environmental/questionnaire\\_gascooling](http://www.lechler.de/environmental/questionnaire_gascooling)



Data collection sheet for design of a DeNOx system

[www.lechler.de/environmental/questionnaire\\_denox](http://www.lechler.de/environmental/questionnaire_denox)

## FULL INFORMATION IS JUST A CLICK AWAY: THE LECHLER WEBSITE



Our website contains further information on our products as well as useful resources.

[www.lechler.com](http://www.lechler.com)

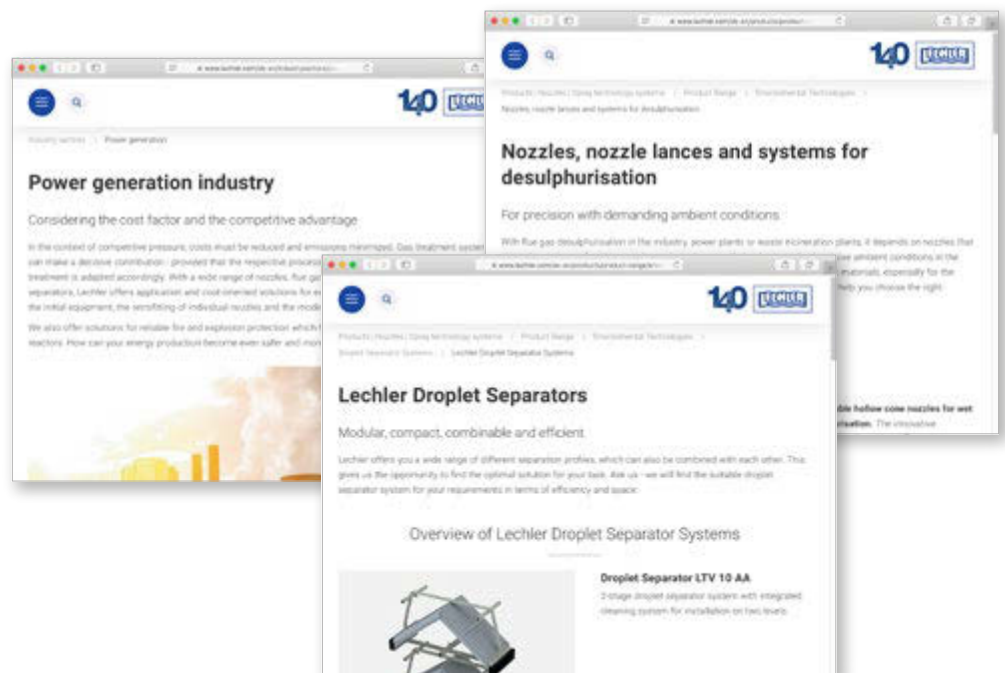

**ENGINEERING  
YOUR SPRAY SOLUTION**



## LECHLER WORLDWIDE

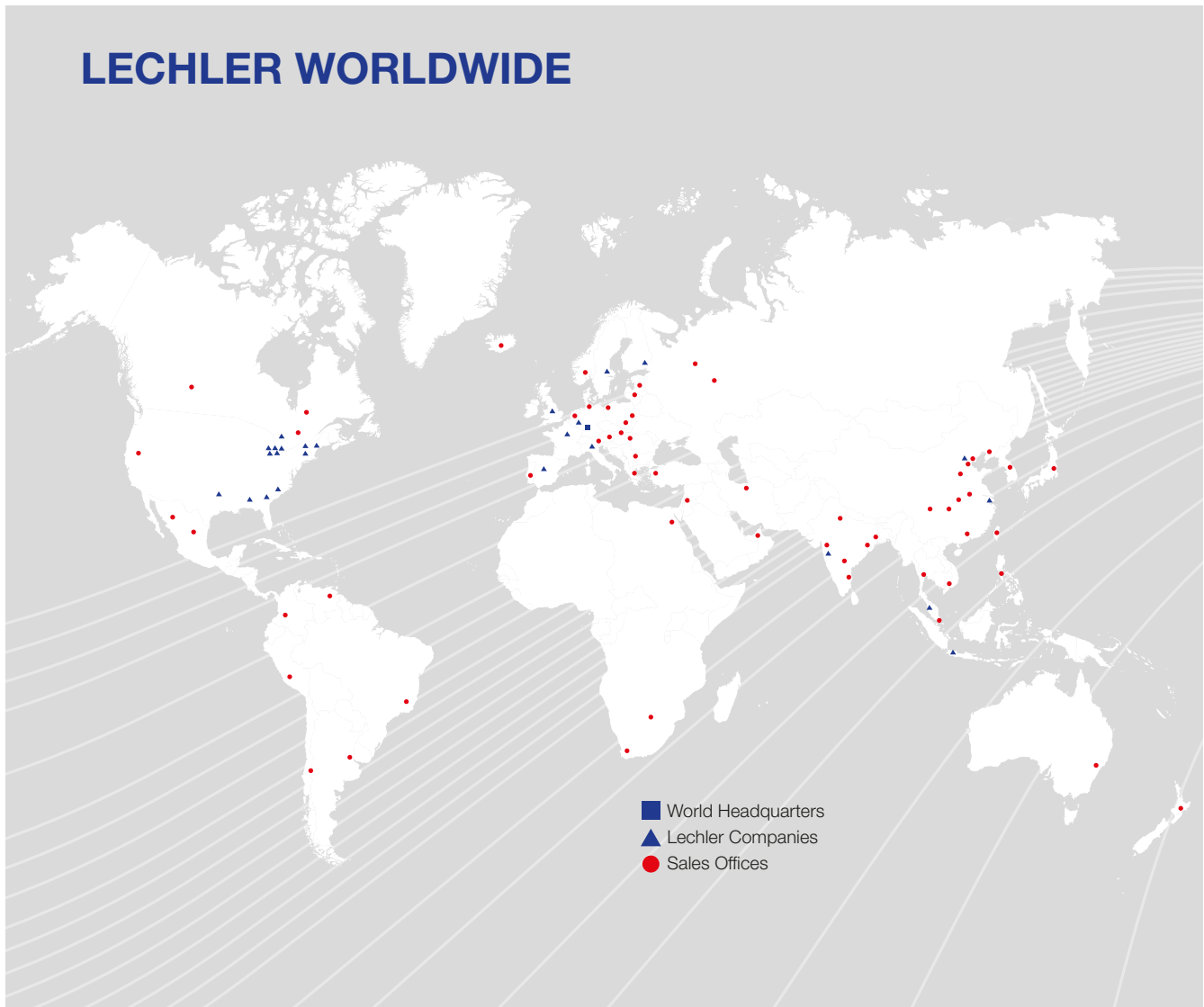

- World Headquarters
- ▲ Lechler Companies
- Sales Offices

### **Lechler GmbH · Precision Nozzles · Nozzle Systems**

**P.O. Box 13 23 · 72544 Metzingen, Germany · Phone: +49 7123 962-0 · Fax: +49 7123 962-301 · info@lechler.de · www.lechler.com**

**ASEAN:** Lechler Spray Technology Sdn. Bhd. · No. 23, Jalan Teknologi 3/3A · Taman Sains Selangor 1 · Kota Damansara, PJU 5 · 47810 Petaling Jaya · Malaysia · info@lechler.com.my

**Belgium:** Lechler S.A./N.V. · Avenue Mercator 6 · 1300 Wavre · Phone: +32 10 225022 · Fax: +32 10 243901 · info@lechler.be

**China:** Lechler Intl. Trad. Co. Ltd. · Beijing · Rm. 418 Landmark Tower · No. 8 Dong San Huan Bei Lu · Phone: +86 10 84537968, Fax: +86 10 84537458 · info@lechler.com.cn

**Finland:** Lechler Oy · Jäspiilänkatu 18 · 04250 Kerava · Phone: +358 207 856880 · Fax: +358 207 856881 · info@lechler.fi

**France:** Lechler France, SAS · Bât. CAP2 · 66-72, Rue Marceau · 93558 Montreuil · Phone: +33 1 49882600 · Fax: +33 1 49882609 · info@lechler.fr

**Great Britain:** Lechler Ltd. · 1 Fell Street, Newhall · Sheffield, S9 2TP · Phone: +44 114 2492020 · Fax: +44 114 2493600 · info@lechler.com

**India:** Lechler (India) Pvt. Ltd. · Plot B-2 · Main Road · Wagle Industrial Estate · Thane (W) · 400604 · Phone: +91 22 40634444 · Fax: +91 22 40634497 · lechler@lechlerindia.com

**Italy:** Lechler Spray Technology S.r.l. · Via Don Dossetti 2 · 20080 Carpiano (Mi) · Phone: +39 02 98859027 · Fax: +39 02 9815647 · info@lechleritalia.com

**Spain:** Lechler S.A. · Avda. Pirineos 7 · Oficina B7, Edificio Inbisa I · 28700 San Sebastián de los Reyes, Madrid · Phone: +34 91 6586346 · Fax: +34 91 6586347 · info@lechler.es

**Sweden:** Lechler AB · Kungsängsvägen 31 B · 753 23 Uppsala · Phone: +46 18 167030 · Fax: +46 18 167031 · info@lechler.se

**USA:** Lechler Inc. · 445 Kautz Road · St. Charles, IL. 60174 · Phone: +1 630 3776611 · Fax: +1 630 3776657 · info@lechlerUSA.com